

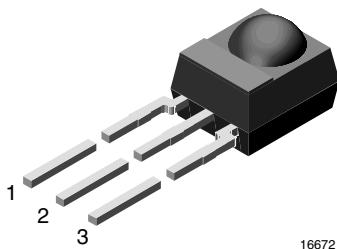

IR Receiver Module for Light Barrier Systems



FEATURES

- Low supply current
- Photo detector and preamplifier in one package
- Internal filter for 38 kHz IR signals
- Shielding against EMI
- Supply voltage: 2.7 V to 5.5 V
- Visible light is suppressed by IR filter
- Insensitive to supply voltage ripple and noise
- Material categorization: For definitions of compliance please see www.vishay.com/doc?99912



MECHANICAL DATA

Pinning:

1 = OUT, 2 = GND., 3 = V_S

DESCRIPTION

The TSOP4038 is a compact IR receiver for sensor applications. It has a high gain for IR signals at 38 kHz. The detection level does not change when ambient light or strong IR signals are applied. It can receive continuous 38 kHz signals or 38 kHz bursts.

PARTS TABLE	
CARRIER FREQUENCY	SENSOR APPLICATIONS
38 kHz	TSOP4038

BLOCK DIAGRAM

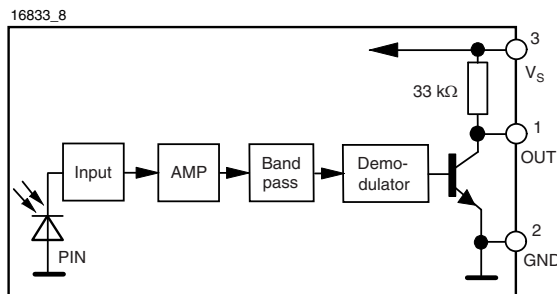

APPLICATION CIRCUIT

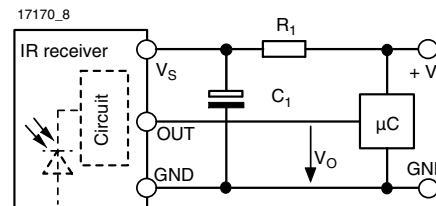

The external components R₁ and C₁ are optional to improve the robustness against electrical overstress (typical values are R₁ = 100 Ω, C₁ = 0.1 μF). The output voltage V_O should not be pulled down to a level below 1 V by the external circuit. The capacitive load at the output should be less than 2 nF.

ABSOLUTE MAXIMUM RATINGS				
PARAMETER	TEST CONDITION	SYMBOL	VALUE	UNIT
Supply voltage (pin 3)		V _S	- 0.3 to + 6.0	V
Supply current (pin 3)		I _S	5	mA
Output voltage (pin 1)		V _O	- 0.3 to 5.5	V
Voltage at output to supply		V _S - V _O	- 0.3 to (V _S + 0.3)	V
Output current (pin 1)		I _O	5	mA
Junction temperature		T _j	100	°C
Storage temperature range		T _{stg}	- 25 to + 85	°C
Operating temperature range		T _{amb}	- 25 to + 85	°C
Power consumption	T _{amb} ≤ 85 °C	P _{tot}	10	mW

Note

- Stresses beyond those listed under "Absolute Maximum Ratings" may cause permanent damage to the device. This is a stress rating only and functional operation of the device at these or any other conditions beyond those indicated in the operational sections of this specification is not implied. Exposure to absolute maximum rating conditions for extended periods may affect the device reliability.



ELECTRICAL AND OPTICAL CHARACTERISTICS ($T_{amb} = 25\text{ }^{\circ}\text{C}$, unless otherwise specified)						
PARAMETER	TEST CONDITION	SYMBOL	MIN.	TYP.	MAX.	UNIT
Supply current (pin 3)	$E_v = 0, V_s = 5\text{ V}$	I_{SD}	0.65	0.85	1.05	mA
	$E_v = 40\text{ klx, sunlight}$	I_{SH}		0.95		mA
Supply voltage		V_s	2.7		5.5	V
Transmission distance	$E_v = 0$, test signal see fig. 1, IR diode TSAL6200, $I_F = 400\text{ mA}$	d		30		m
Output voltage low (pin 1)	$I_{OSL} = 0.5\text{ mA}$, $E_e = 2\text{ mW/m}^2$, test signal see fig. 1	V_{OSL}			100	mV
Minimum irradiance	Pulse width tolerance: $t_{pi} - 5/f_0 < t_{po} < t_{pi} + 6/f_0$, test signal see fig. 1	$E_e\text{ min.}$		0.3	0.7	mW/m^2
Maximum irradiance	$t_{pi} - 5/f_0 < t_{po} < t_{pi} + 6/f_0$, test signal see fig. 1	$E_e\text{ max.}$	30			W/m^2
Directivity	Angle of half transmission distance	$\phi_{1/2}$		± 45		deg

TYPICAL CHARACTERISTICS ($T_{amb} = 25\text{ }^{\circ}\text{C}$, unless otherwise specified)

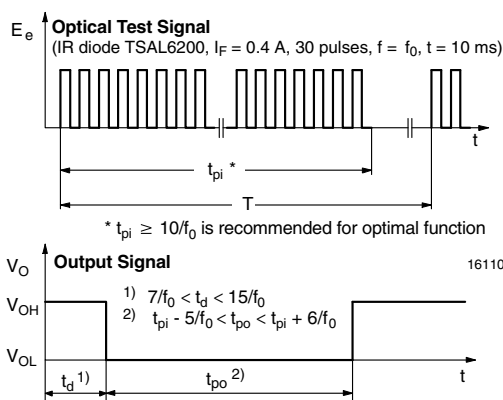

Fig. 1 - Output Active Low

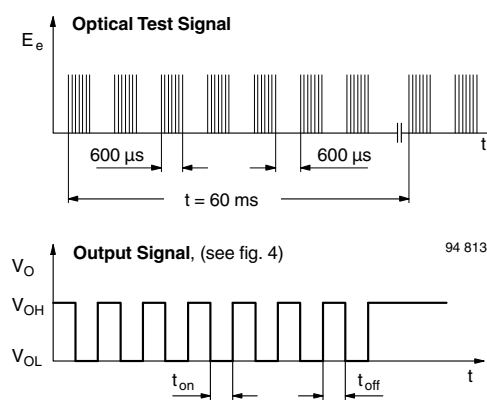

Fig. 3 - Output Function

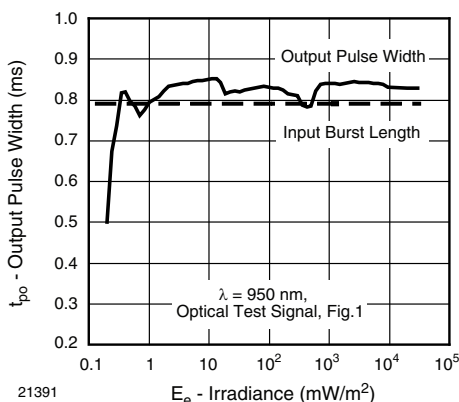

Fig. 2 - Pulse Length and Sensitivity in Dark Ambient

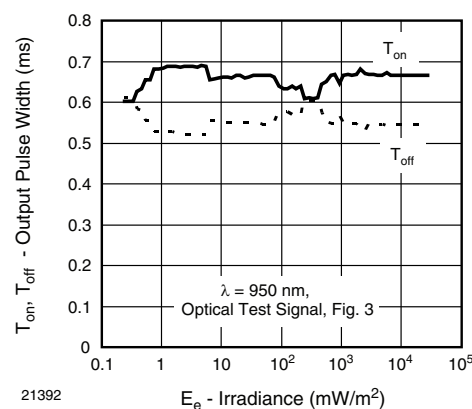

Fig. 4 - Output Pulse Diagram

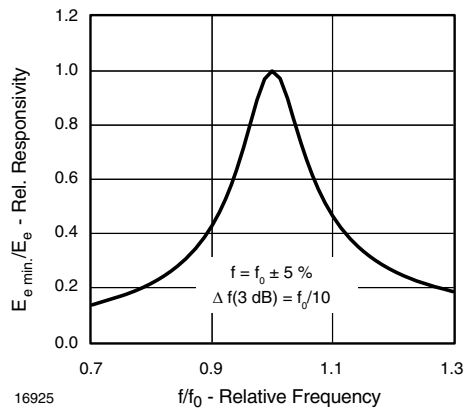

Fig. 5 - Frequency Dependence of Responsivity

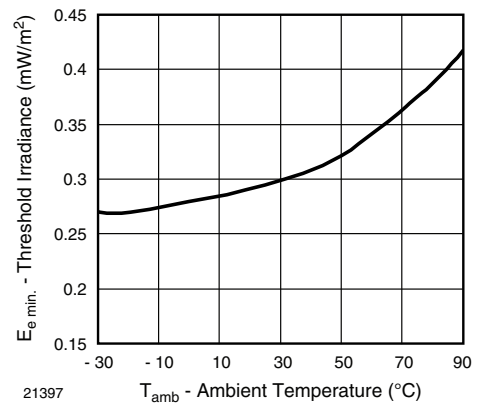

Fig. 8 - Sensitivity vs. Ambient Temperature

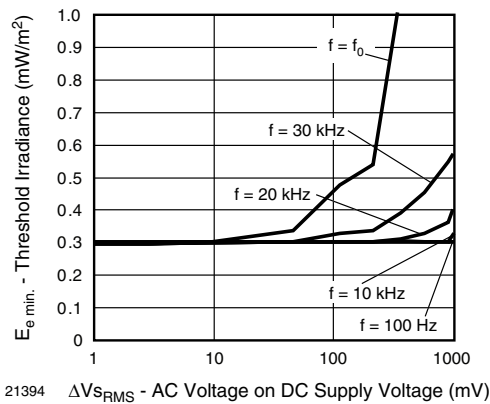

Fig. 6 - Sensitivity vs. Supply Voltage Disturbances

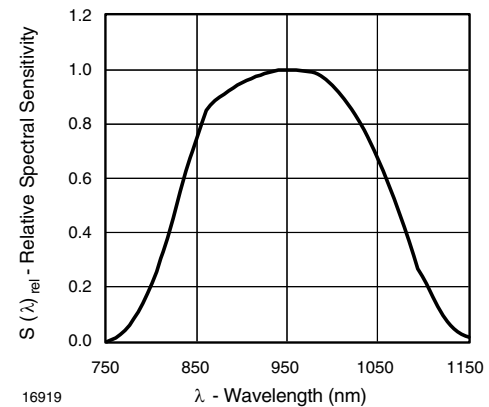

Fig. 9 - Relative Spectral Sensitivity vs. Wavelength

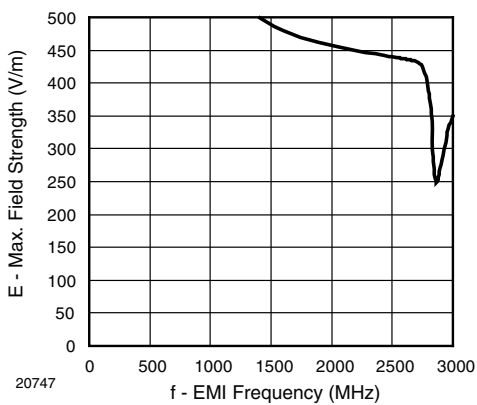

Fig. 7 - Sensitivity vs. Electric Field Disturbances

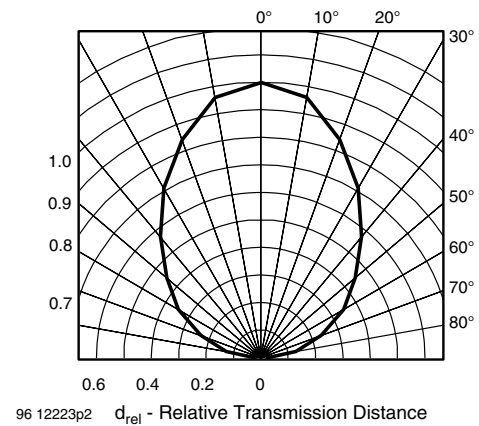

Fig. 10 - Directivity

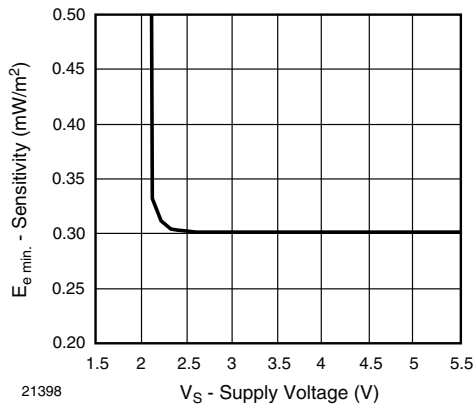
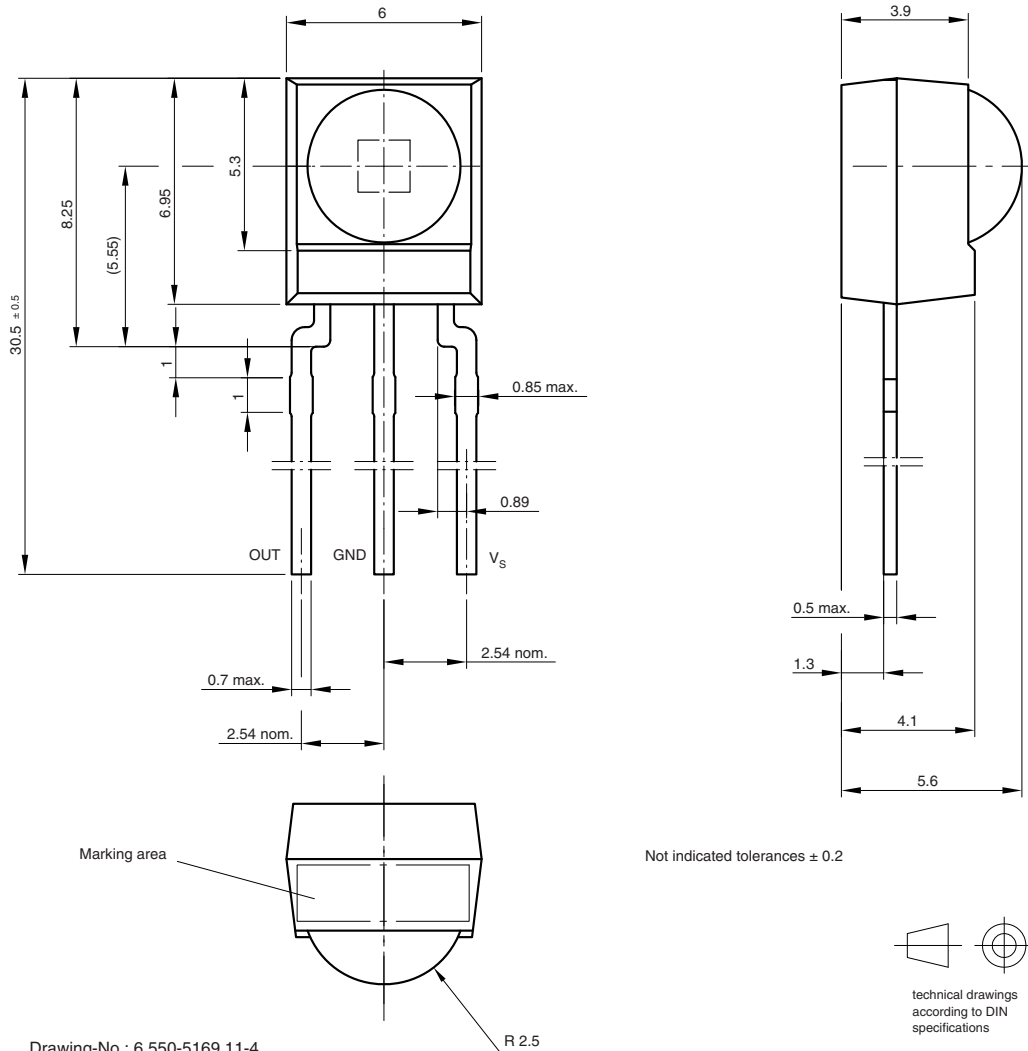

Fig. 11 - Sensitivity vs. Supply Voltage

PACKAGE DIMENSIONS in millimeters



Drawing-No.: 6.550-5169.11-4
 Issue: 13; 17.12.08
 16003



Disclaimer

ALL PRODUCT, PRODUCT SPECIFICATIONS AND DATA ARE SUBJECT TO CHANGE WITHOUT NOTICE TO IMPROVE RELIABILITY, FUNCTION OR DESIGN OR OTHERWISE.

Vishay Intertechnology, Inc., its affiliates, agents, and employees, and all persons acting on its or their behalf (collectively, "Vishay"), disclaim any and all liability for any errors, inaccuracies or incompleteness contained in any datasheet or in any other disclosure relating to any product.

Vishay makes no warranty, representation or guarantee regarding the suitability of the products for any particular purpose or the continuing production of any product. To the maximum extent permitted by applicable law, Vishay disclaims (i) any and all liability arising out of the application or use of any product, (ii) any and all liability, including without limitation special, consequential or incidental damages, and (iii) any and all implied warranties, including warranties of fitness for particular purpose, non-infringement and merchantability.

Statements regarding the suitability of products for certain types of applications are based on Vishay's knowledge of typical requirements that are often placed on Vishay products in generic applications. Such statements are not binding statements about the suitability of products for a particular application. It is the customer's responsibility to validate that a particular product with the properties described in the product specification is suitable for use in a particular application. Parameters provided in datasheets and / or specifications may vary in different applications and performance may vary over time. All operating parameters, including typical parameters, must be validated for each customer application by the customer's technical experts. Product specifications do not expand or otherwise modify Vishay's terms and conditions of purchase, including but not limited to the warranty expressed therein.

Hyperlinks included in this datasheet may direct users to third-party websites. These links are provided as a convenience and for informational purposes only. Inclusion of these hyperlinks does not constitute an endorsement or an approval by Vishay of any of the products, services or opinions of the corporation, organization or individual associated with the third-party website. Vishay disclaims any and all liability and bears no responsibility for the accuracy, legality or content of the third-party website or for that of subsequent links.

Except as expressly indicated in writing, Vishay products are not designed for use in medical, life-saving, or life-sustaining applications or for any other application in which the failure of the Vishay product could result in personal injury or death. Customers using or selling Vishay products not expressly indicated for use in such applications do so at their own risk. Please contact authorized Vishay personnel to obtain written terms and conditions regarding products designed for such applications.

No license, express or implied, by estoppel or otherwise, to any intellectual property rights is granted by this document or by any conduct of Vishay. Product names and markings noted herein may be trademarks of their respective owners.