

- \* High Dielectric strength over 4KV
- \* High Isolation strength over 100MΩ/500VDC
- \* With over heat protection Circuit ( 120°C )
- \* High surge current sustenance
- \* High surge voltage sustenance
- \* Conformity with EN60947-4-3 and EN60950

- \* 高電介強度超過4KV
- \* 高絕緣強度超過100MΩ/500VDC
- \* 附過熱保護回路可防止過熱破壞
- \* 耐瞬間電流超過額定電流10倍以上
- \* 附雙重突波吸收回路有效防止突波破壞
- \* 符合EN60947-4-3 and EN60950標準

**Guiding of model / 型號索引**

**Terminal type / 端子式**

Ex: **SSR – 40 D A – H – R**  
           1      2      3 4      5      6

**1> Product / 產品**

- 「SSR」= Single phase solid state module
- 「HPR」= High power solid state module
- 「TSR」= Three phases solid state module
- 「ESR」= Three phases High power solid state module
- 「EZR」= Plug type solid state module

**2> Output current / 輸出電流**

- 「10」= 10A   「25」= 25A   「40」= 40A
- 「50」= 50A   「60」= 60A   「80」= 80A

**3> Input method / 輸入方式**

- 「D」= 4 ~ 32VDC
- 「A」= 80 ~ 250VAC
- 「L」= 4 ~ 20mA
- 「V」= Variable resistor

**4> Output voltage / 輸出電壓**

- 「A」= AC voltage
- 「D」= DC voltage

**5> Output voltage range / 輸出電壓範圍**

- 「H」= High voltage type
- 「Non」= Standard type

**6> Control method / 控制方式**

- 「R」= Random control
- 「Non」= Zero cross control

**PCB or Fuse type / 基板或保險絲型**

Ex: **SSR – P 03 D A – H**  
           1      2 3      4 5      6

**1> Product / 產品**

- 「SSR」= Single phase solid state module
- 「SCR」= Single phase linear solid state module

**2> Mounting method or Others**

- 「P」= PCB type
- 「M」= Mini PCB type
- 「Y」= Relay type
- 「R」= Relay type
- 「K」= Heat-sink type
- 「F」= Fuse type

**3> Output current / 輸出電流**

- 「03」= 3A   「10」= 10A
- 「25」= 25A   「40」= 40A

**4> Input method / 輸入方式**

- 「D」= 4 ~ 32VDC
- 「A」= 80 ~ 250VAC
- 「L」= 4 ~ 20mA

**5> Output voltage / 輸出電壓**

- 「A」= AC voltage
- 「D」= DC voltage

**6> Output voltage range / 輸出電壓範圍**

- 「H」= High voltage type
- 「Non」= Standard type

Control method / 控制方式

**Zero cross trigger method**

Output will be turned ON or Turned OFF only on the Zero point of sine wave, that may avoid to occur the EMI or RFI. Specially suited to control the resistive, capacitive and non-saturated inductive load.

輸出只有在正弦波的零點上有輸入訊號時才會打開或關閉，以避免產生突波或EMI / RFI。特別適用於控制阻抗性或電容性或不飽和感抗性等負載。

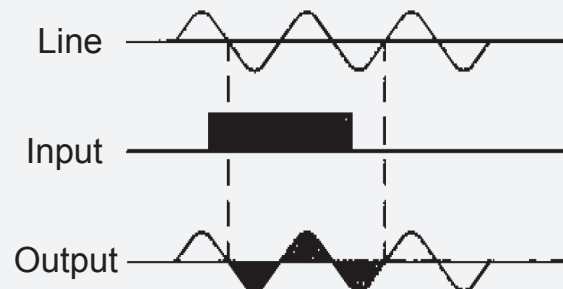

**Variable resistance control method ( Trimmer control )**

Power output is controlled by the Trigger angle of the Triac that is controlled with variable resistor.

( 250KΩ/110VAC, 500KΩ/220VAC, 1MΩ/220VAC )  
 以可變電阻控制Triac的觸發角來控制輸出功率。  
 ( 250KΩ/110VAC, 500KΩ/220VAC, 1MΩ/380VAC )

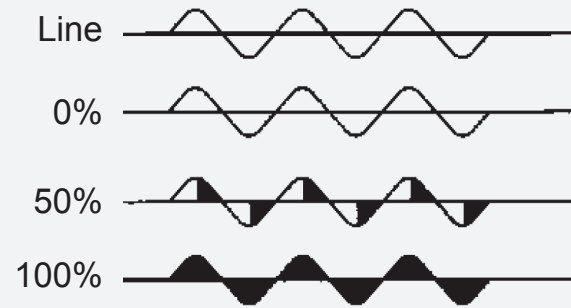

Application hints / 應用說明

Input	NPN	Output status	NO	Input	PNP	Output status	NO	Input	L.S.	Output status	NO
Input	NPN	Output status	NC	Input	PNP	Output status	NC	Latch circuit ( AC to AC )			

## ■ Specification [ Rated current corresponding to Resistive load ]

Type	型式	Standard type / 標準型				
Model	型號	SSR - 05DD	SSR - 10DD	SSR-25DD	SSR-50DD	SSR-75DD
Rated current	額定電流	5A max.	10A max.	25A max	50A max	75A max
Surge current	耐突波電流	15A max.	30A max.	50A max.	150A max.	225A max.
Peak voltage	耐突波電壓	300VDC	300VDC	600VDC	600VDC	600VDC
Response time	反應時間	1.0 ms			1.0 ms	
Output voltage	輸出電壓	5 ~ 60VDC			5 ~ 120VDC	

Type	型式	High voltage type / 高壓型		
Model	型號	SSR-25DD-H	SSR-50DD-H	SSR-75DD-H
Rated current	額定電流	25A max	50A max	75A max
Surge current	耐突波電流	50A max.	150A max.	225A max.
Peak voltage	耐突波電壓	600VDC	600VDC	600VDC
Response time	反應時間	1.0 ms		
Output voltage	輸出電壓	5 ~ 300VDC		

General specification / 共同規格		
Input voltage	輸入電壓	4 ~ 32 VDC
Turn off voltage	關閉電壓	< 3.0 VDC
Trigger current	觸發電流	12mA max.
Control method	控制方式	Random
Leakage current	洩漏電流	1.0 mA
Response time	反應時間	1.0 ms
Input immunity	輸入耐突波	2 KV ( EN61000-4-4 )
Isolation strength	電介強度	4 KVrms ( EN60950/VDE0805 )
Insulation strength	絕緣強度	100MΩ / 500VDC ( EN60950/VDE0805 )
Circumstance	工作環境	-40°C ~ +80°C ; 35 ~ 85%RH

## ■ Outline dimension / 外形尺寸

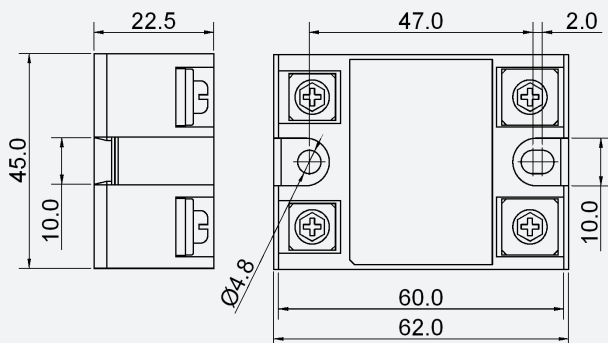

## ■ Connection / 接線圖

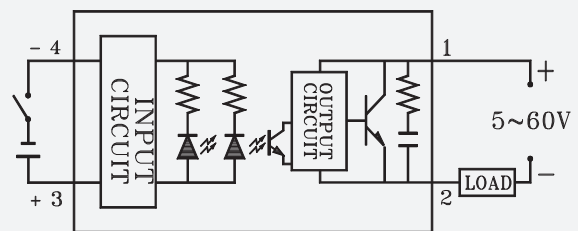

## How to use Heat sink & Cooling Fan for HPR series / 如何使用散熱器及冷卻風扇

Line current (Average current / 平均電流)	Heat sink	Cooling fan
$I_L < 5$ Amps	Non-required	Non-required
$I_L < 12$ Amps	HS-50H	Non-required
$I_L < 25$ Amps	HS-ESR-60	Non-required
$I_L > 25$ Amps	HS-ESR-60	Required

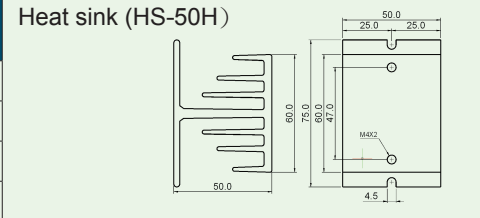

## Notice of use / 使用注意事項

- To protect the solid state module against a short-circuit of the load, please use a fuse with a **I<sup>2</sup>t value** < 1/2 I<sup>2</sup>t value specified.  
請加裝快速保險絲（I<sup>2</sup>t value 小於額定值的一半），以防止因負載短路而造成固態模組燒毀。
- The thermal conductive silicone rubber or thermal grease is required  
When the solid state module is mounted on a heat sink  
本固態模組加裝散熱器時務必墊高導熱系數的矽膠片或散熱膏【導熱系數（K）> 4.5】。
- The rated current is corresponding to a resistive load, if the solid state module is applied in other loads, Please consider the inrush current at turn on and the surge voltage at turn off.  
本固態模組所標示的額定電流是以電阻性負載為準，如果使用在其他負載上須考慮起動電流及關機突波。
  - Electric discharge lamps: Those loads have the 「inrush current」 at turn on and the 「surge voltage」 at turn off, please use 「high voltage type」 on 220VAC mains.  
電子起動式燈具（如日光燈）：須考慮起動電流及關機突波，220VAC電源系統請選用「高壓型」。
  - Incandescent lamp: The rated current of the module must be over 4 times of the incandescent lamp current.  
炙熱燈泡（如IR燈管）：須考慮起動電流，固態模組的額定電流須大於炙熱燈泡電流的「四倍」。
  - Three phase motors: The rated current of the s module must be over 4 times of the three phase motor average current .  
三相馬達：須考慮起動電流，固態模組的額定電流須大於三相馬達平均電流的「四倍」。
  - Transformer loads: The rated current of the module must be over 10 times of the transformer current.  
變壓器負載：須考慮反電動電流，固態模組的額定電流須大於變壓負載電流的「十倍」。
  - Capacitor loads, the rated current of the module must be over 3 times of the capacitor current .  
電容性負載：須考慮充電瞬間電流，固態模組的額定電流須大於電容性負載電流的「三倍」。

## Notice of safety / 安全注意事項

### Warning

**Potentially hazardous situation, if mishandling, may result in death or serious injury.**  
潛在危險，如果操作失當可能導致死亡或嚴重傷害。

- Please do not touch any terminal of this module while power supply is supplied, if do, it may result in electronic shock.  
送電中，請勿碰觸本固態模組任何接線端子以避免觸電。
- 「Power supply system」 must to be shutdown before renew the fuse, if not, it may result in electronic shock.  
更換保險絲前，請務必關閉電源系統以避免觸電。
- Please rated the load current within the specified value, if not, it may result to burn up this module or fuse.  
負載電流請勿超過額定電流，以避免保險絲或本固態模組燒毀。
- Please tighten the screw terminal over 35Kg/cm<sup>2</sup>, if not, it may result to burn up this module or fuse.  
請務必鎖緊端子螺絲，扭力須超過35Kg/cm<sup>2</sup>，否則可能導致本固態模組或保險絲燒毀。
- If this module is burned up, it may be in short circuit condition or malfunction, Please settle an independent alarm system to ensure safety protection, if not, it may result in a serious accident.  
本固態模組燒毀後可能是短路或失控狀態，請加裝獨立警報系統以確保安全，否則可能造成嚴重意外事故。

H type

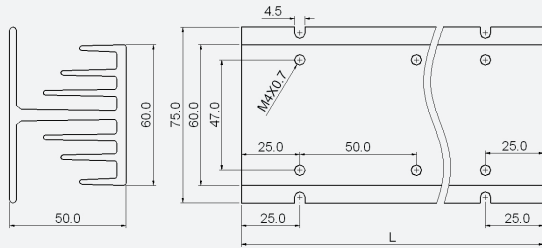

Model	Length(L mm)	Current duration	PCS for SSR
HS-50H	50.0	10A max.	Single
HS-100H	100.0	20A max.	Twice
HS-150H	150.0	30A max.	Three
HS-200H	200.0	---	Four

H type Rail bracket (HS-BR-1)

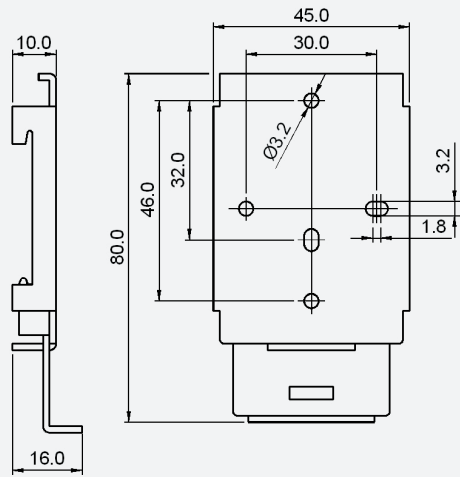

Standard type

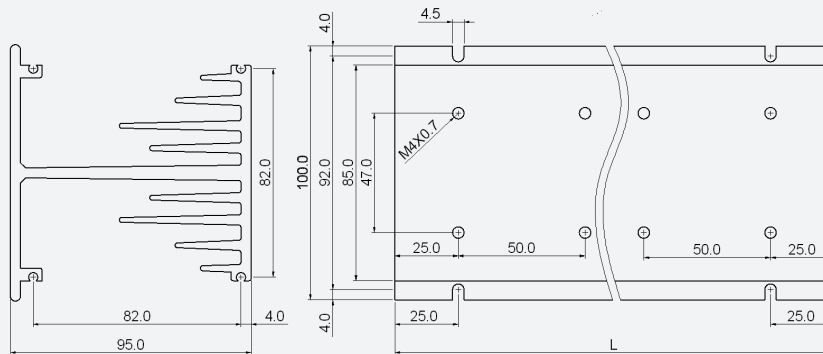

Model	Length(L mm)	Current duration	PCS for SSR
HS-50	50.0	15A max.	Single
HS-100	100.0	30A max.	Twice
HS-150	150.0	50A max.	Three
HS-200	200.0	---	Four
HS-250	250.0	---	Five

How to use Heat sink & Cooling Fan for ESR series / 如何使用散熱器及冷卻風扇

Line current (Average current / 平均電流)	Heat sink	Cooling fan	Calculating of Line current 線電流計算
IL < 5 Amps	Non-required	Non-required	$I_L = W \div (\sqrt{3} \times V_L \times \cos\theta)$ $I_L = W \div (\sqrt{3} \times V_L \times \cos\theta)$ VL: Line voltage; cosθ: Power factor
IL < 10 Amps	HS-ESR-100	Non-required	
IL > 10 Amps	HS-ESR-100	Required	

\* Model of Heat sink: HS-ESR-100 \* Outline of cooling fan: 80mm x 80mm