

Laser PM2.5 Sensor specification

Product model: SDS011

Version: V1.3



Nova Fitness Co., Ltd.

2015-10-9

Contents

OVERVIEW	1
CHARACTERISTICS	1
SCOPE OF APPLICATION	2
WORKING PRINCIPLE.....	2
TECHNICAL PARAMETERS.....	2
POWER REQUIREMENT.....	3
ABOUT SERVICE LIFE.....	4
PRODUCT SPECIFICATIONS	4
1.Product size.....	4
2. Interface specification.....	4
THE UART COMMUNICATION PROTOCOL	5
PWM output description.....	6
Schematic diagram of output:	7
EXTENDED FUNCTIONALITY	7
INSTALLATION SIZE.....	7
PACKAGE	10
MATTERS NEEDING ATTENTION	11
CONTACT	11

Overview

The SDS011 using principle of laser scattering, can get the particle concentration between 0.3 to 10 μ m in the air. It with digital output and built-in fan is stable and reliable.

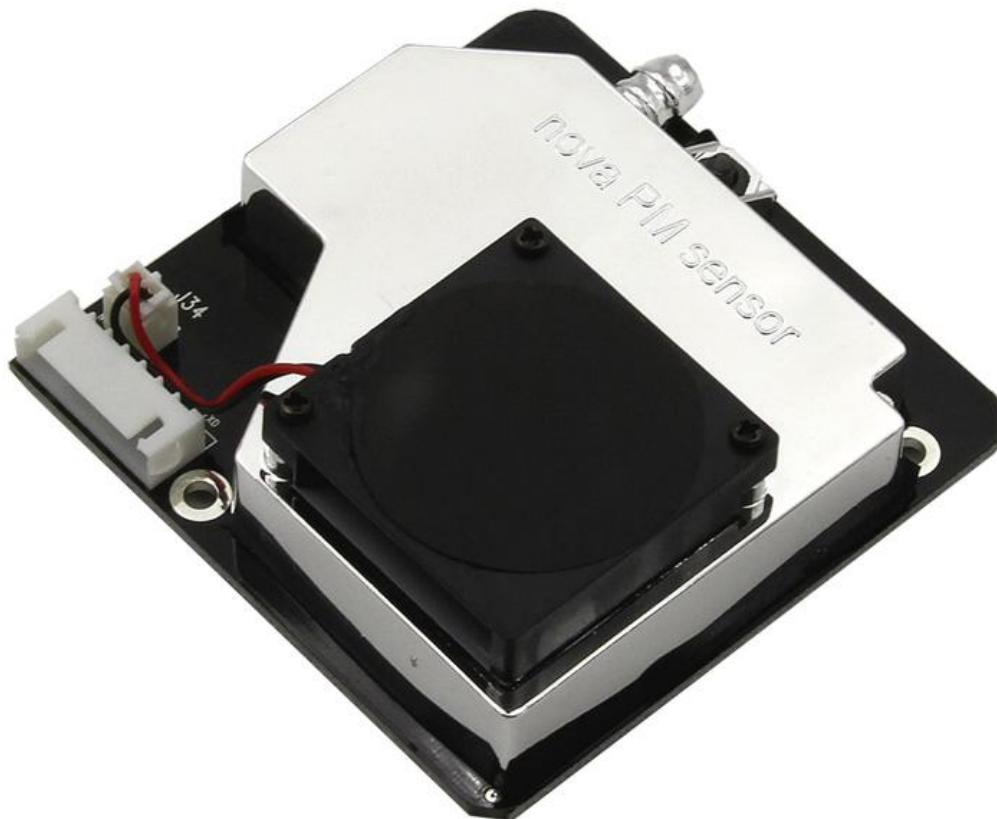

Characteristics

1. Accurate and Reliable: laser detection, stable, good consistency;
2. Quick response: response time is less than 10 seconds when the scene changes;
3. Easy integration: UART output (or IO output can be customized), fan built-in;
4. High resolution: resolution of 0.3 μ g/m³;

5.Certification: products have passed CE/FCC/RoHS certification.

Scope of application

Detector of PM2.5;Purifier.

Working principle

Using laser scattering principle:

Light scattering can be induced when particles go through the detecting area. The scattered light is transformed into electrical signals and these signals will be amplified and processed. The number and diameter of particles can be obtained by analysis because the signal waveform has certain relations with the particles diameter.

Technical Parameters

No	Item	Parameter	Note
1	Measurement parameters	PM2.5,PM10	
2	Range	0.0-999.9 $\mu\text{g} / \text{m}^3$	
3	Rated voltage	5V	
4	Rated current	70mA \pm 10mA	
5	Sleep current	<4 mA	Lase&Fan sleep
6	Temperature range	Storage environment: -20 ~ +60 $^{\circ}\text{C}$	

		Work environment: -10 ~ +50°C	
7	Humidity range	Storage environment: Max 90%	
		Work environment: Max 70%	
8	Air pressure	86KPa~110KPa	
9	Corresponding time	1s	
10	Serial data output frequency	1Hz	
11	Minimum resolution of particle	0.3 μm	
12	Counting yield	70% @0.3μm 98% @0.5μm	
13	Relative error	Maximum of ± 15% and ±10μg/m ³	25°C, 50%RH
14	Product size	71x70x23mm	
15	Certification	CE/FCC/RoHS	

Power requirement

Power Voltage: 4.7~5.3V

Power supply: >1W

Supply voltage ripple: <20mV

About service life

Service life is the key parameter of laser dust sensor. The laser diode in this sensor has high quality and its service life is up to 8000 hours. If you need real-time data (such as detector), you can use the default configuration that measures at the frequency of 1time per second. On the occasion of real-time demand is not high (such as filter, air quality monitoring, etc.), you can use the discontinuous working method to prolong the service life. For example, you can start the sensor for 30 seconds per minutes. If you have any other requirements, please contact us, we are willing to serve for manufacturers and developers.

Product specifications

1.Product size

L*W*H=71*70*23mm

2.Interface specification

No	Name	Comment
1	NC	Not Connect
2	1 μ m	PM2.5: 0-999 μ g/m ³ ;PWM Output
3	5V	5V Input
4	2.5 μ m	PM10: 0-999 μ g/m ³ ;PWM Output
5	GND	Ground

6	R	RX of UART (TTL) @3.3V
7	T	TX of UART (TTL) @3.3V

PS: The distance between each pin is 2.54mm.

The UART communication protocol

Bit rate : 9600

Data bit : 8

Parity bit: NO

Stop bit : 1

Data Packet frequency: 1Hz

The number of bytes	Name	Content
0	Message header	AA
1	Commander No.	C0
2	DATA 1	PM2.5 Low byte
3	DATA 2	PM2.5 High byte
4	DATA 3	PM10 Low byte
5	DATA 4	PM10 High byte
6	DATA 5	ID byte 1
7	DATA 6	ID byte 2
8	Check-sum	Check-sum
9	Message tail	AB

Check-sum: Check-sum=DATA1+DATA2+...+DATA6 。

PM2.5 value: $PM2.5 (\mu g / m^3) = ((PM2.5 \text{ High byte} * 256) + PM2.5 \text{ low byte}) / 10$

PM10 value: $PM10 (\mu g / m^3) = ((PM10 \text{ high byte} * 256) + PM10 \text{ low byte}) / 10$

PWM output description

Range of PM2.5 value	0-999 $\mu g / m^3$
Range of PM10 value	0-999 $\mu g / m^3$
Cycle	1004ms \pm 1%
High level output time at the beginning of the whole cycle	2ms
The middle time of this cycle	1000ms \pm 1%
Low level output time at the end of the whole cycle	2ms

Schematic diagram of output :

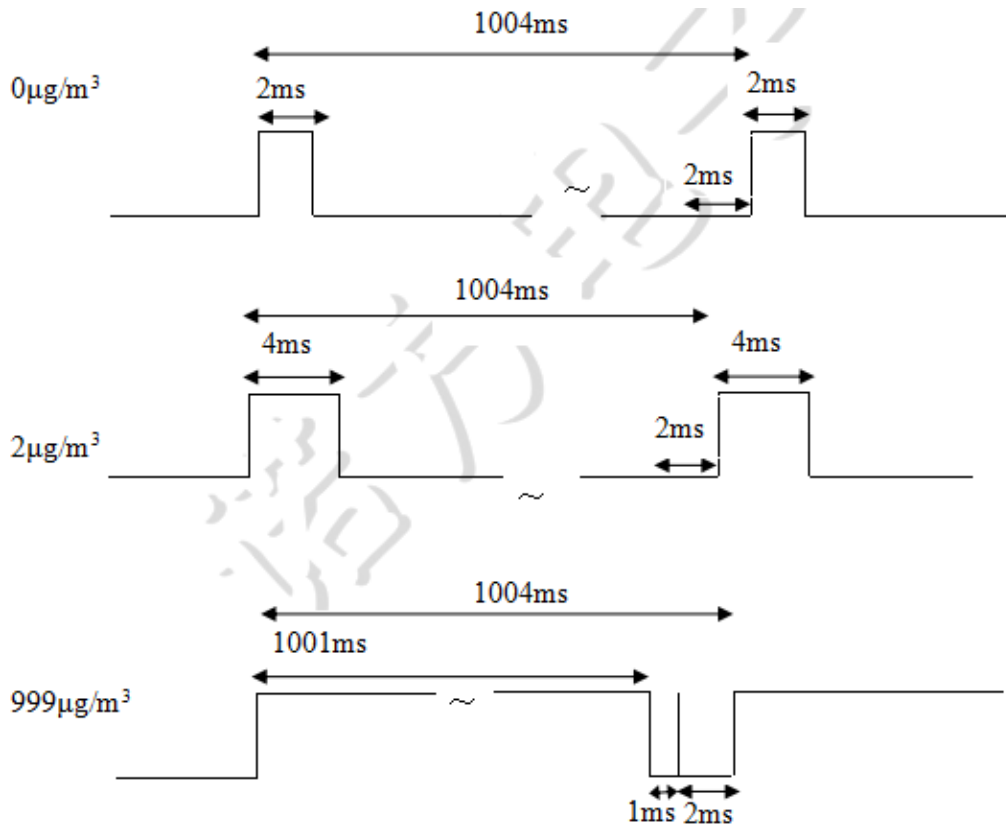

Extended functionality

1. Manual hibernation(Sleep and wake up)
2. Timed hibernate(Cycle to work)
3. User ID setting
4. Set data reporting mode(Active report and query report)
5. Version number query

If you have any other requirements, please contact us.

Installation size

1. Basic structure

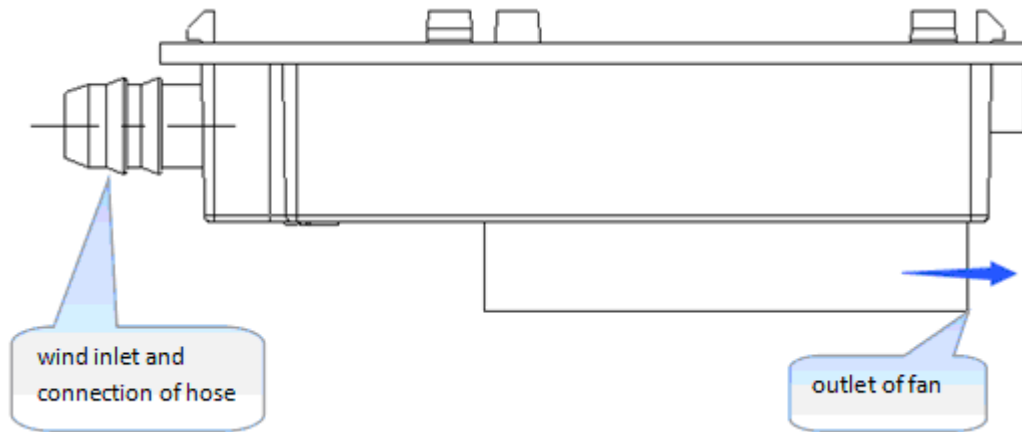

2. Basic dimensions

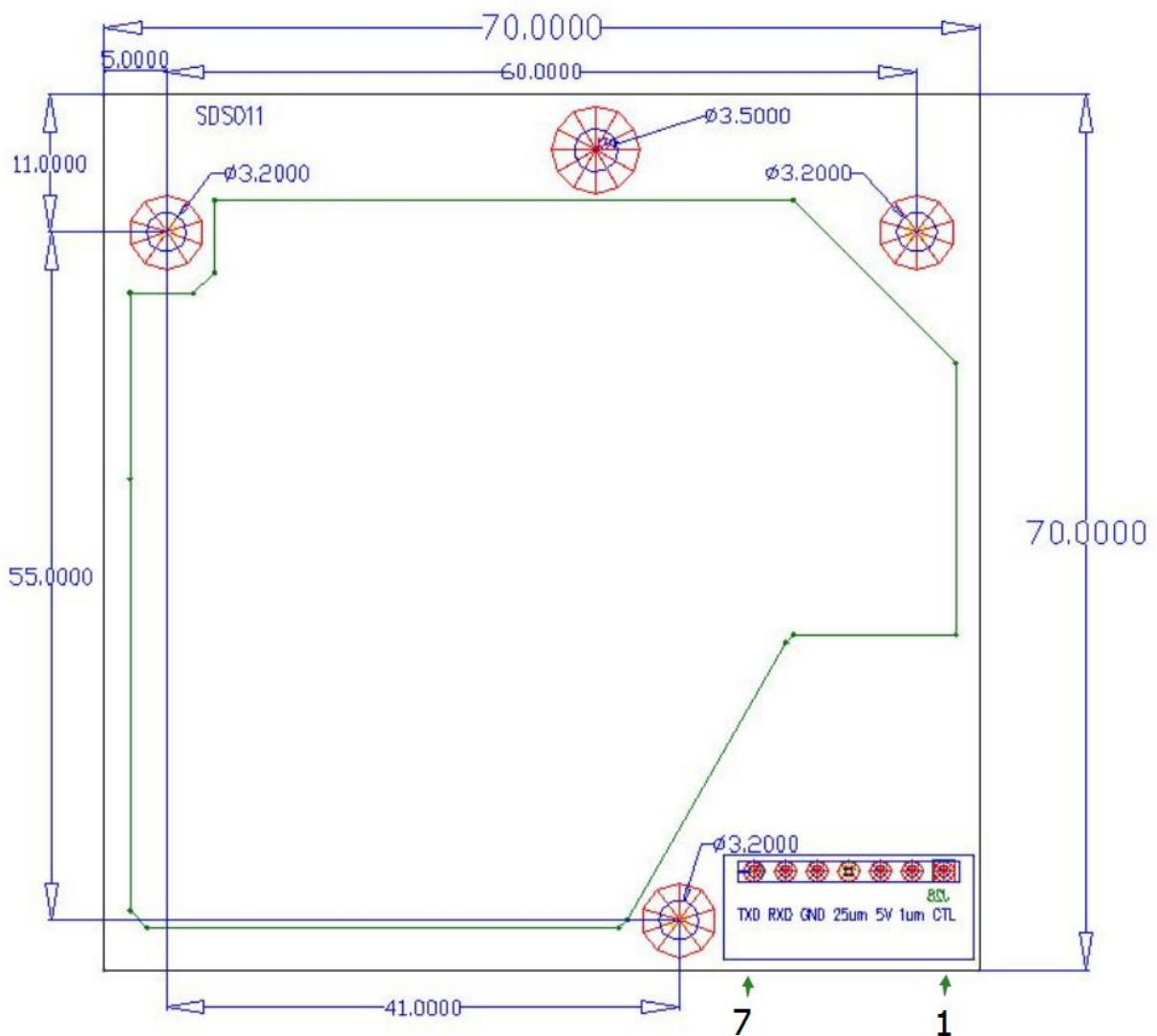

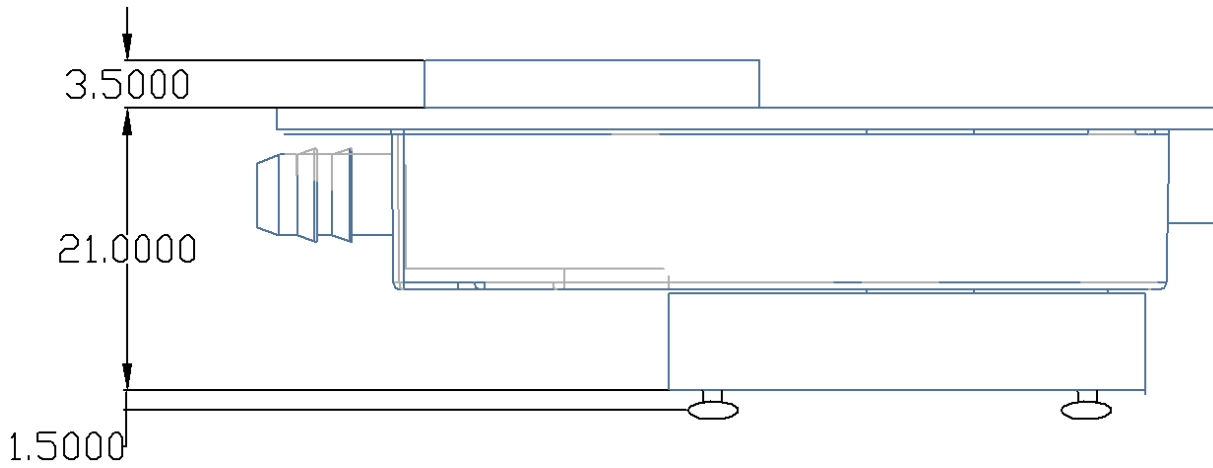

3. Recommended installation direction

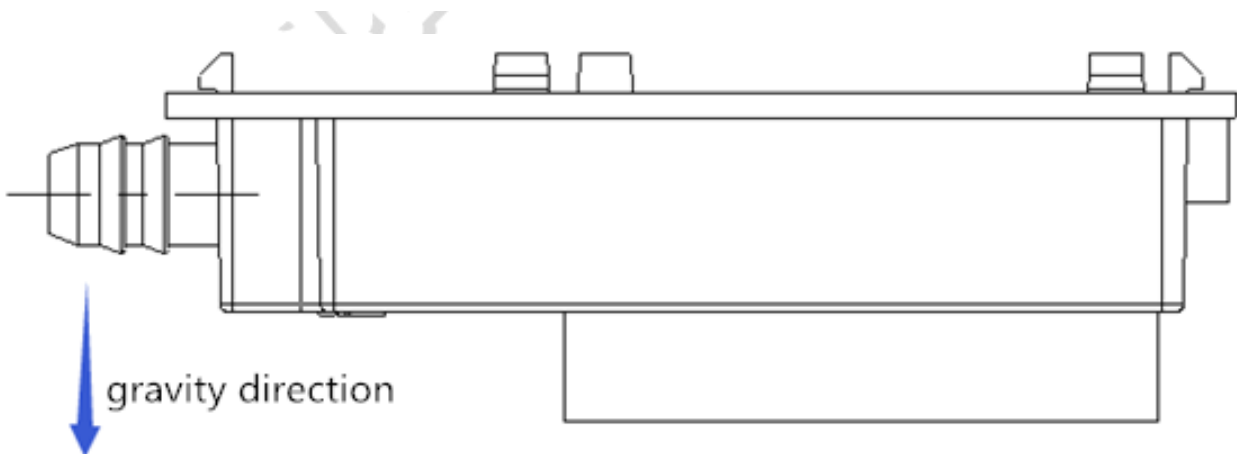
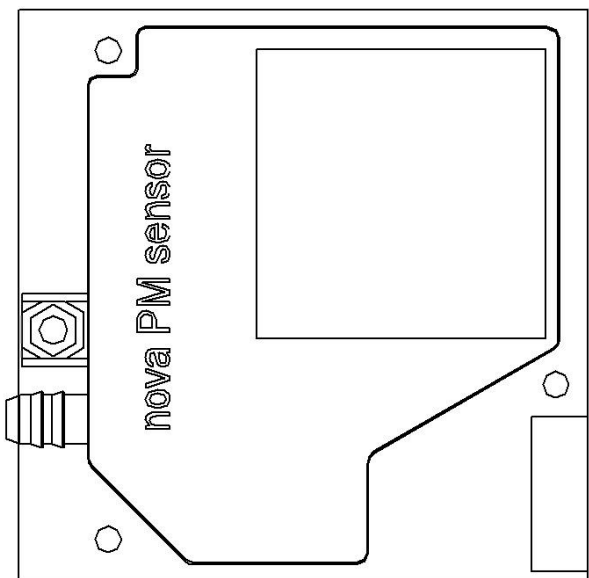
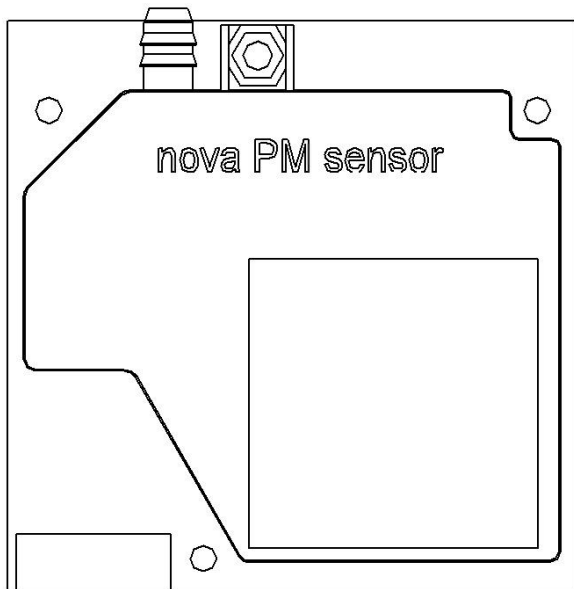

4. Hose connection: optional. It can be connected with the hose of 6mm inner diameter and 8mm external diameter. The hose cannot be longer

than 1m, the shorter the better. The hose must keep the air flowing.

5. Prevent glare: the sensor has shading device inside, so it can work normally under the common light. You should pay attention to prevent the inlet, outlet from direct light.

6. Keep the inlet and outlet unobstructed.

Package



There are 20 sensors on each floor



Each box: $9 \times 20 = 180$

Matters needing attention

1. In the context of the sensor power supply;
2. Note the process design to ensure smoothness and stability of sensor airflow;
3. Please ensure that the sensor to work under normal conditions of temperature and humidity;
4. Avoid severe vibration during transport, so as not to affect the accuracy of detection and accuracy;
5. Follow this specification is the correct sensor installation.
6. Do not light into the air inlet.

Contact

Nova Fitness Co., Ltd.

TEL: +86-0531-82868288

FAX: +86-0531-82868198

ADD: Room203, Building A

Jinan International Innovative

Design Industrial Park

WEB: www.inovafitness.com