

No.	Linear Actuator Parameters	
1	Stroke(mm)	100±3
2	Installation size(mm)	290±3
3	Voltage(v dc)	24
4	Free load speed(mm/s)	13
5	Full load speed(mm/s)	7
6	Dynamic load capacity(n)	10000
7	Cable thickness	twin-core 15awg
8	Cable length (mm)	1000±50
9	Signal Cable thickness	four-core 24awg
10	Cable length (mm)	1000±50
11	Front mounting end	thru hole Ø13
12	Rear mounting end	thru hole Ø13
13	Wire connector	tinned bare wires
14	Limit switches	Built in, unadjustable
15	Potentiometer	10KΩ
16	Hall sensor	n/a
17	Protection Rate	IP66
18	Free load current (amp)	2
19	Full load current (amp)	15

Power Wiring Diagram		
	Black	Red
Extend	-	+
Retract	+	-

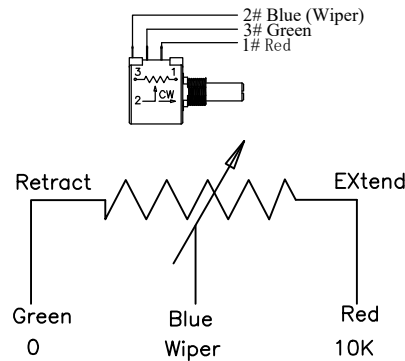

Comfirm by customer						
Signature:				Date:		
A	SAMPLE ISSUE			Jeason	24.05.17	
REV.	DESCRIPTION			BY	DATE	APPD. DATE
UNIT.	MM	SCALE	MATERIAL	NAME		LINEAR ACTUATOR 608
TOL.		SHEET		DRAWING NO.		YMD608-24051703
		1/1		Wuxi East Yu Xiang science and Technology Co., Ltd.		