

2N3906

General Purpose Transistors

PNP Silicon

Features

- Pb-Free Packages are Available*

MAXIMUM RATINGS

Rating	Symbol	Value	Unit
Collector - Emitter Voltage	V_{CEO}	40	Vdc
Collector - Base Voltage	V_{CBO}	40	Vdc
Emitter - Base Voltage	V_{EBO}	5.0	Vdc
Collector Current - Continuous	I_C	200	mA _{dc}
Total Device Dissipation @ $T_A = 25^\circ\text{C}$ Derate above 25°C	P_D	625 5.0	mW mW/ $^\circ\text{C}$
Total Power Dissipation @ $T_A = 60^\circ\text{C}$	P_D	250	mW
Total Device Dissipation @ $T_C = 25^\circ\text{C}$ Derate above 25°C	P_D	1.5 12	W mW/ $^\circ\text{C}$
Operating and Storage Junction Temperature Range	T_J, T_{stg}	-55 to +150	$^\circ\text{C}$

THERMAL CHARACTERISTICS (Note 1)

Characteristic	Symbol	Max	Unit
Thermal Resistance, Junction-to-Ambient	$R_{\theta JA}$	200	$^\circ\text{C}/\text{W}$
Thermal Resistance, Junction-to-Case	$R_{\theta JC}$	83.3	$^\circ\text{C}/\text{W}$

Stresses exceeding Maximum Ratings may damage the device. Maximum Ratings are stress ratings only. Functional operation above the Recommended Operating Conditions is not implied. Extended exposure to stresses above the Recommended Operating Conditions may affect device reliability.

1. Indicates Data in addition to JEDEC Requirements.



ON Semiconductor®

<http://onsemi.com>

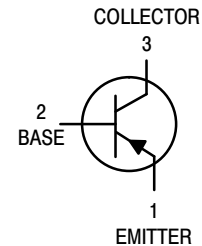

TO-92
CASE 29
STYLE 1

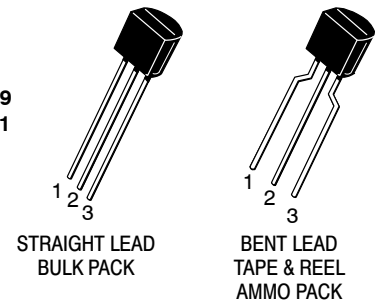

MARKING DIAGRAM

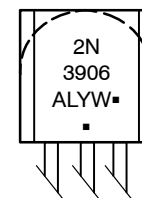

A = Assembly Location
L = Wafer Lot
Y = Year
W = Work Week
▪ = Pb-Free Package

(Note: Microdot may be in either location)

ORDERING INFORMATION

See detailed ordering and shipping information in the package dimensions section on page 3 of this data sheet.

*For additional information on our Pb-Free strategy and soldering details, please download the ON Semiconductor Soldering and Mounting Techniques Reference Manual, SOLDERRM/D.

2N3906

ELECTRICAL CHARACTERISTICS ($T_A = 25^\circ\text{C}$ unless otherwise noted)

Characteristic	Symbol	Min	Max	Unit
----------------	--------	-----	-----	------

OFF CHARACTERISTICS

Collector – Emitter Breakdown Voltage (Note 2)	$(I_C = 1.0 \text{ mAdc}, I_B = 0)$	$V_{(BR)CEO}$	40	–	Vdc
Collector – Base Breakdown Voltage	$(I_C = 10 \text{ }\mu\text{Adc}, I_E = 0)$	$V_{(BR)CBO}$	40	–	Vdc
Emitter – Base Breakdown Voltage	$(I_E = 10 \text{ }\mu\text{Adc}, I_C = 0)$	$V_{(BR)EBO}$	5.0	–	Vdc
Base Cutoff Current	$(V_{CE} = 30 \text{ Vdc}, V_{EB} = 3.0 \text{ Vdc})$	I_{BL}	–	50	nAdc
Collector Cutoff Current	$(V_{CE} = 30 \text{ Vdc}, V_{EB} = 3.0 \text{ Vdc})$	I_{CEX}	–	50	nAdc

ON CHARACTERISTICS (Note 2)

DC Current Gain	$(I_C = 0.1 \text{ mAdc}, V_{CE} = 1.0 \text{ Vdc})$	h_{FE}	60	–	–	
	$(I_C = 1.0 \text{ mAdc}, V_{CE} = 1.0 \text{ Vdc})$		80	–	–	
	$(I_C = 10 \text{ mAdc}, V_{CE} = 1.0 \text{ Vdc})$		100	300	–	–
	$(I_C = 50 \text{ mAdc}, V_{CE} = 1.0 \text{ Vdc})$		60	–	–	–
	$(I_C = 100 \text{ mAdc}, V_{CE} = 1.0 \text{ Vdc})$		30	–	–	–
Collector – Emitter Saturation Voltage	$(I_C = 10 \text{ mAdc}, I_B = 1.0 \text{ mAdc})$ $(I_C = 50 \text{ mAdc}, I_B = 5.0 \text{ mAdc})$	$V_{CE(sat)}$	– –	0.25 0.4	Vdc	
Base – Emitter Saturation Voltage	$(I_C = 10 \text{ mAdc}, I_B = 1.0 \text{ mAdc})$ $(I_C = 50 \text{ mAdc}, I_B = 5.0 \text{ mAdc})$	$V_{BE(sat)}$	0.65 –	0.85 0.95	Vdc	

SMALL-SIGNAL CHARACTERISTICS

Current – Gain – Bandwidth Product	$(I_C = 10 \text{ mAdc}, V_{CE} = 20 \text{ Vdc}, f = 100 \text{ MHz})$	f_T	250	–	MHz
Output Capacitance	$(V_{CB} = 5.0 \text{ Vdc}, I_E = 0, f = 1.0 \text{ MHz})$	C_{obo}	–	4.5	pF
Input Capacitance	$(V_{EB} = 0.5 \text{ Vdc}, I_C = 0, f = 1.0 \text{ MHz})$	C_{ibo}	–	10	pF
Input Impedance	$(I_C = 1.0 \text{ mAdc}, V_{CE} = 10 \text{ Vdc}, f = 1.0 \text{ kHz})$	h_{ie}	2.0	12	k Ω
Voltage Feedback Ratio	$(I_C = 1.0 \text{ mAdc}, V_{CE} = 10 \text{ Vdc}, f = 1.0 \text{ kHz})$	h_{re}	0.1	10	X 10^{-4}
Small-Signal Current Gain	$(I_C = 1.0 \text{ mAdc}, V_{CE} = 10 \text{ Vdc}, f = 1.0 \text{ kHz})$	h_{fe}	100	400	–
Output Admittance	$(I_C = 1.0 \text{ mAdc}, V_{CE} = 10 \text{ Vdc}, f = 1.0 \text{ kHz})$	h_{oe}	3.0	60	μmhos
Noise Figure	$(I_C = 100 \text{ }\mu\text{Adc}, V_{CE} = 5.0 \text{ Vdc}, R_S = 1.0 \text{ k}\Omega, f = 1.0 \text{ kHz})$	NF	–	4.0	dB

SWITCHING CHARACTERISTICS

Delay Time	$(V_{CC} = 3.0 \text{ Vdc}, V_{BE} = 0.5 \text{ Vdc}, I_C = 10 \text{ mAdc}, I_{B1} = 1.0 \text{ mAdc})$	t_d	–	35	ns
Rise Time		t_r	–	35	ns
Storage Time	$(V_{CC} = 3.0 \text{ Vdc}, I_C = 10 \text{ mAdc}, I_{B1} = I_{B2} = 1.0 \text{ mAdc})$	t_s	–	225	ns
Fall Time	$(V_{CC} = 3.0 \text{ Vdc}, I_C = 10 \text{ mAdc}, I_{B1} = I_{B2} = 1.0 \text{ mAdc})$	t_f	–	75	ns

2. Pulse Test: Pulse Width $\leq 300 \text{ }\mu\text{s}$; Duty Cycle $\leq 2\%$.

2N3906

ORDERING INFORMATION

Device	Package	Shipping†
2N3906	TO-92	5000 Units / Bulk
2N3906G	TO-92 (Pb-Free)	5000 Units / Bulk
2N3906RL1	TO-92	2000 / Tape & Reel
2N3906RL1G	TO-92 (Pb-Free)	2000 / Tape & Reel
2N3906RLRA	TO-92	2000 / Tape & Reel
2N3906RLRAG	TO-92 (Pb-Free)	2000 / Tape & Reel
2N3906RLRM	TO-92	2000 / Tape & Ammo Box
2N3906RLRMG	TO-92 (Pb-Free)	2000 / Tape & Ammo Box
2N3906RLRP	TO-92	2000 / Tape & Ammo Box
2N3906RLRPG	TO-92 (Pb-Free)	2000 / Tape & Ammo Box

†For information on tape and reel specifications, including part orientation and tape sizes, please refer to our Tape and Reel Packaging Specifications Brochure, BRD8011/D.



* Total shunt capacitance of test jig and connectors

Figure 1. Delay and Rise Time Equivalent Test Circuit

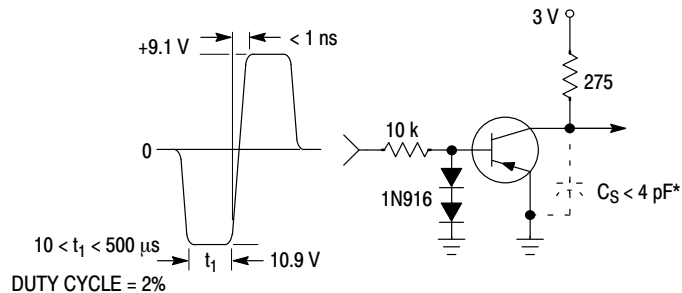

* Total shunt capacitance of test jig and connectors

Figure 2. Storage and Fall Time Equivalent Test Circuit

TYPICAL TRANSIENT CHARACTERISTICS

— $T_J = 25^\circ\text{C}$
 - - - $T_J = 125^\circ\text{C}$



Figure 3. Capacitance

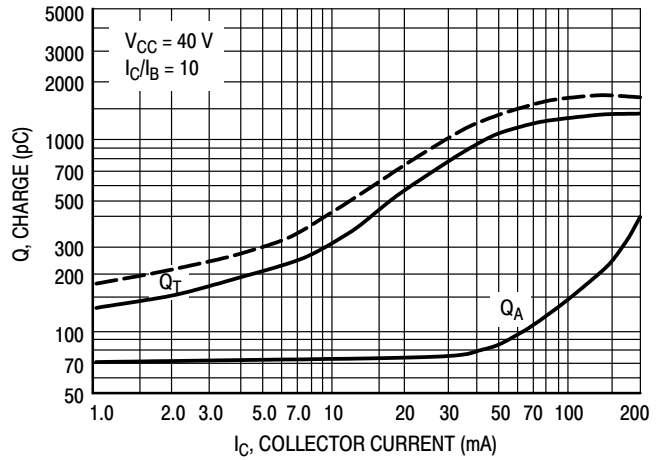

Figure 4. Charge Data

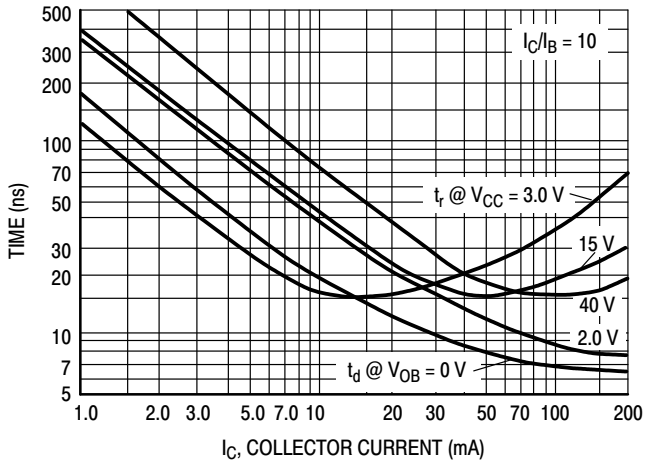

Figure 5. Turn-On Time

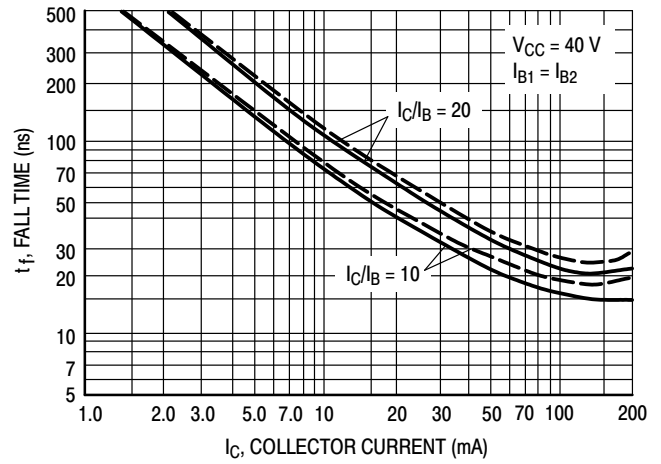

Figure 6. Fall Time

**TYPICAL AUDIO SMALL-SIGNAL CHARACTERISTICS
NOISE FIGURE VARIATIONS**

($V_{CE} = -5.0$ Vdc, $T_A = 25^\circ\text{C}$, Bandwidth = 1.0 Hz)



Figure 7.



Figure 8.

h PARAMETERS

($V_{CE} = -10$ Vdc, $f = 1.0$ kHz, $T_A = 25^\circ\text{C}$)



Figure 9. Current Gain



Figure 10. Output Admittance



Figure 11. Input Impedance



Figure 12. Voltage Feedback Ratio

TYPICAL STATIC CHARACTERISTICS

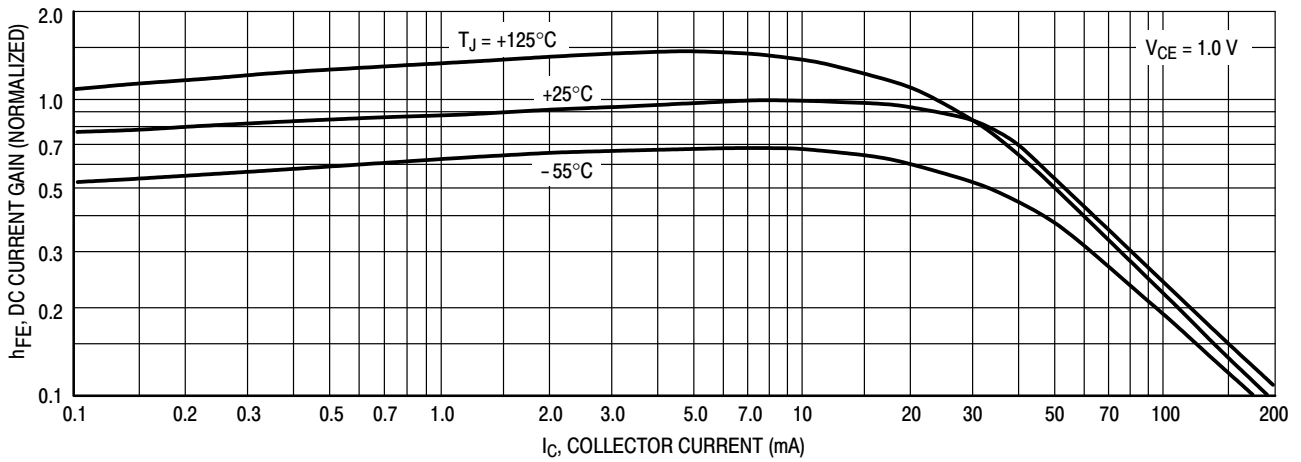

Figure 13. DC Current Gain

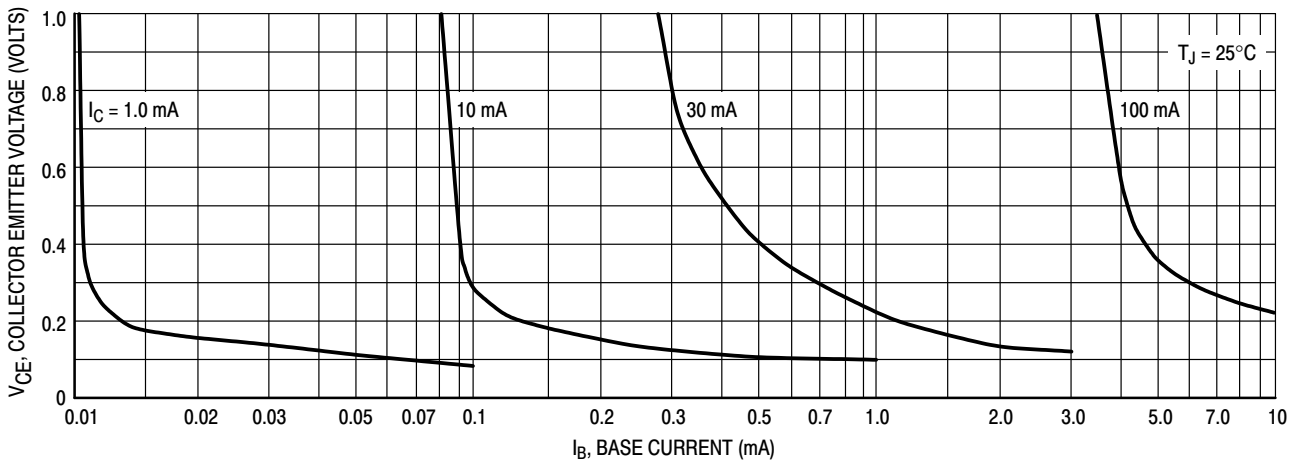

Figure 14. Collector Saturation Region



Figure 15. "ON" Voltages

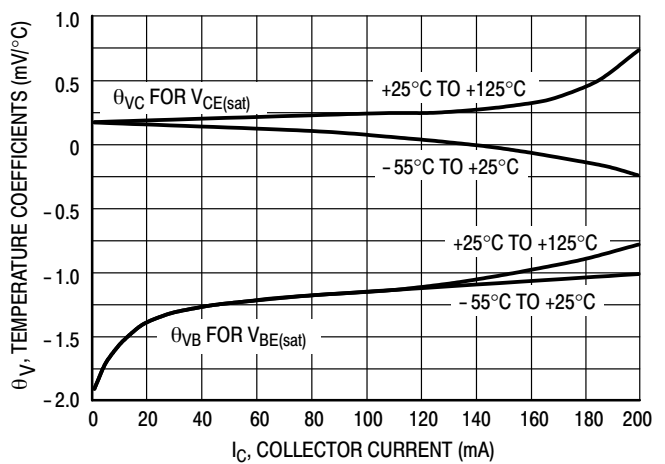

Figure 16. Temperature Coefficients

MECHANICAL CASE OUTLINE PACKAGE DIMENSIONS

ON Semiconductor®



SCALE 1:1



TO-92 (TO-226)
CASE 29-11
ISSUE AM

DATE 09 MAR 2007



STRAIGHT LEAD
BULK PACK



NOTES:

1. DIMENSIONING AND TOLERANCING PER ANSI Y14.5M, 1982.
2. CONTROLLING DIMENSION: INCH.
3. CONTOUR OF PACKAGE BEYOND DIMENSION R IS UNCONTROLLED.
4. LEAD DIMENSION IS UNCONTROLLED IN P AND BEYOND DIMENSION K MINIMUM.

DIM	INCHES		MILLIMETERS	
	MIN	MAX	MIN	MAX
A	0.175	0.205	4.45	5.20
B	0.170	0.210	4.32	5.33
C	0.125	0.165	3.18	4.19
D	0.016	0.021	0.407	0.533
G	0.045	0.055	1.15	1.39
H	0.095	0.105	2.42	2.66
J	0.015	0.020	0.39	0.50
K	0.500	---	12.70	---
L	0.250	---	6.35	---
N	0.080	0.105	2.04	2.66
P	---	0.100	---	2.54
R	0.115	---	2.93	---
V	0.135	---	3.43	---



BENT LEAD
TAPE & REEL
AMMO PACK



NOTES:

1. DIMENSIONING AND TOLERANCING PER ASME Y14.5M, 1994.
2. CONTROLLING DIMENSION: MILLIMETERS.
3. CONTOUR OF PACKAGE BEYOND DIMENSION R IS UNCONTROLLED.
4. LEAD DIMENSION IS UNCONTROLLED IN P AND BEYOND DIMENSION K MINIMUM.

DIM	MILLIMETERS	
	MIN	MAX
A	4.45	5.20
B	4.32	5.33
C	3.18	4.19
D	0.40	0.54
G	2.40	2.80
J	0.39	0.50
K	12.70	---
N	2.04	2.66
P	1.50	4.00
R	2.93	---
V	3.43	---

STYLES ON PAGE 2

DOCUMENT NUMBER:	98ASB42022B	Electronic versions are uncontrolled except when accessed directly from the Document Repository. Printed versions are uncontrolled except when stamped "CONTROLLED COPY" in red.
STATUS:	ON SEMICONDUCTOR STANDARD	
NEW STANDARD:		
DESCRIPTION:	TO-92 (TO-226)	PAGE 1 OF 3

TO-92 (TO-226)
CASE 29-11
ISSUE AM

DATE 09 MAR 2007

STYLE 1:
 PIN 1. EMITTER
 2. BASE
 3. COLLECTOR

STYLE 2:
 PIN 1. BASE
 2. EMITTER
 3. COLLECTOR

STYLE 3:
 PIN 1. ANODE
 2. ANODE
 3. CATHODE

STYLE 4:
 PIN 1. CATHODE
 2. CATHODE
 3. ANODE

STYLE 5:
 PIN 1. DRAIN
 2. SOURCE
 3. GATE

STYLE 6:
 PIN 1. GATE
 2. SOURCE & SUBSTRATE
 3. DRAIN

STYLE 7:
 PIN 1. SOURCE
 2. DRAIN
 3. GATE

STYLE 8:
 PIN 1. DRAIN
 2. GATE
 3. SOURCE & SUBSTRATE

STYLE 9:
 PIN 1. BASE 1
 2. EMITTER
 3. BASE 2

STYLE 10:
 PIN 1. CATHODE
 2. GATE
 3. ANODE

STYLE 11:
 PIN 1. ANODE
 2. CATHODE & ANODE
 3. CATHODE

STYLE 12:
 PIN 1. MAIN TERMINAL 1
 2. GATE
 3. MAIN TERMINAL 2

STYLE 13:
 PIN 1. ANODE 1
 2. GATE
 3. CATHODE 2

STYLE 14:
 PIN 1. EMITTER
 2. COLLECTOR
 3. BASE

STYLE 15:
 PIN 1. ANODE 1
 2. CATHODE
 3. ANODE 2

STYLE 16:
 PIN 1. ANODE
 2. GATE
 3. CATHODE

STYLE 17:
 PIN 1. COLLECTOR
 2. BASE
 3. EMITTER

STYLE 18:
 PIN 1. ANODE
 2. CATHODE
 3. NOT CONNECTED

STYLE 19:
 PIN 1. GATE
 2. ANODE
 3. CATHODE

STYLE 20:
 PIN 1. NOT CONNECTED
 2. CATHODE
 3. ANODE

STYLE 21:
 PIN 1. COLLECTOR
 2. EMITTER
 3. BASE

STYLE 22:
 PIN 1. SOURCE
 2. GATE
 3. DRAIN

STYLE 23:
 PIN 1. GATE
 2. SOURCE
 3. DRAIN

STYLE 24:
 PIN 1. EMITTER
 2. COLLECTOR/ANODE
 3. CATHODE

STYLE 25:
 PIN 1. MT 1
 2. GATE
 3. MT 2

STYLE 26:
 PIN 1. V_{CC}
 2. GROUND 2
 3. OUTPUT

STYLE 27:
 PIN 1. MT
 2. SUBSTRATE
 3. MT

STYLE 28:
 PIN 1. CATHODE
 2. ANODE
 3. GATE

STYLE 29:
 PIN 1. NOT CONNECTED
 2. ANODE
 3. CATHODE

STYLE 30:
 PIN 1. DRAIN
 2. GATE
 3. SOURCE

STYLE 31:
 PIN 1. GATE
 2. DRAIN
 3. SOURCE

STYLE 32:
 PIN 1. BASE
 2. COLLECTOR
 3. EMITTER

STYLE 33:
 PIN 1. RETURN
 2. INPUT
 3. OUTPUT

STYLE 34:
 PIN 1. INPUT
 2. GROUND
 3. LOGIC

STYLE 35:
 PIN 1. GATE
 2. COLLECTOR
 3. EMITTER

DOCUMENT NUMBER:	98ASB42022B	Electronic versions are uncontrolled except when accessed directly from the Document Repository. Printed versions are uncontrolled except when stamped "CONTROLLED COPY" in red.
STATUS:	ON SEMICONDUCTOR STANDARD	
NEW STANDARD:		
DESCRIPTION:	TO-92 (TO-226)	PAGE 2 OF 3

onsemi, **Onsemi**, and other names, marks, and brands are registered and/or common law trademarks of Semiconductor Components Industries, LLC dba "**onsemi**" or its affiliates and/or subsidiaries in the United States and/or other countries. **onsemi** owns the rights to a number of patents, trademarks, copyrights, trade secrets, and other intellectual property. A listing of **onsemi**'s product/patent coverage may be accessed at www.onsemi.com/site/pdf/Patent-Marking.pdf. **onsemi** reserves the right to make changes at any time to any products or information herein, without notice. The information herein is provided "as-is" and **onsemi** makes no warranty, representation or guarantee regarding the accuracy of the information, product features, availability, functionality, or suitability of its products for any particular purpose, nor does **onsemi** assume any liability arising out of the application or use of any product or circuit, and specifically disclaims any and all liability, including without limitation special, consequential or incidental damages. Buyer is responsible for its products and applications using **onsemi** products, including compliance with all laws, regulations and safety requirements or standards, regardless of any support or applications information provided by **onsemi**. "Typical" parameters which may be provided in **onsemi** data sheets and/or specifications can and do vary in different applications and actual performance may vary over time. All operating parameters, including "Typicals" must be validated for each customer application by customer's technical experts. **onsemi** does not convey any license under any of its intellectual property rights nor the rights of others. **onsemi** products are not designed, intended, or authorized for use as a critical component in life support systems or any FDA Class 3 medical devices or medical devices with a same or similar classification in a foreign jurisdiction or any devices intended for implantation in the human body. Should Buyer purchase or use **onsemi** products for any such unintended or unauthorized application, Buyer shall indemnify and hold **onsemi** and its officers, employees, subsidiaries, affiliates, and distributors harmless against all claims, costs, damages, and expenses, and reasonable attorney fees arising out of, directly or indirectly, any claim of personal injury or death associated with such unintended or unauthorized use, even if such claim alleges that **onsemi** was negligent regarding the design or manufacture of the part. **onsemi** is an Equal Opportunity/Affirmative Action Employer. This literature is subject to all applicable copyright laws and is not for resale in any manner.

PUBLICATION ORDERING INFORMATION

LITERATURE FULFILLMENT:

Email Requests to: orderlit@onsemi.com

onsemi Website: www.onsemi.com

TECHNICAL SUPPORT

North American Technical Support:
Voice Mail: 1 800-282-9855 Toll Free USA/Canada
Phone: 011 421 33 790 2910

Europe, Middle East and Africa Technical Support:

Phone: 00421 33 790 2910

For additional information, please contact your local Sales Representative