

## 8 PIN SOP PHOTOTRANSISTOR DUAL CHANNEL PHOTOCOUPLER ELD20X Series ELD21X Series

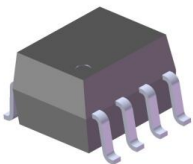

### Features:

- Dual channel coupler
- Current transfer ratios offered in narrow ranges
 

ELD205: 40-80%	ELD211: >20%
ELD206: 63-125%	ELD213: >100%
ELD207: 100-200%	ELD217: >100%
- High isolation voltage between input and output (Viso = 3750 Vrms)
- Operating temperature range of -55 to +110°C
- High BVceo of 80V
- Standard SO-8 footprint package
- Pb free and RoHS compliant.
- UL and cUL approved(No. E214129)
- VDE approval (No. 40028116)
- SEMKO approved
- NEMKO approved
- DEMKO approved
- FIMKO approved

### Schematic

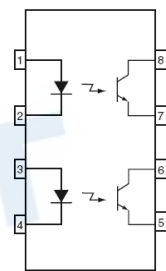

### Pin Configuration

1. Anode
2. Cathode
3. Anode
4. Cathode
5. Emitter
6. Collector
7. Emitter
8. Collector

### Description

The ELD20X and ELD21X series contain two infrared emitting diodes optically coupled to two phototransistor detectors.

The devices are packaged in an 8-pin small outline package which conforms to the standard SO-8 footprint.

### Applications

- Feedback Control Circuits
- Interfacing and coupling systems of different potentials and impedances
- General Purpose Switching Circuits
- Monitor and Detection Circuits

**Absolute Maximum Ratings (Ta=25°C)**

	Parameter	Symbol	Rating	Unit
Input	Forward current	$I_F$	60	mA
	Peak forward current (t = 10μs)	$I_{FM}$	1	A
	Reverse voltage	$V_R$	6	V
	Power dissipation No derating needed	$P_D$	90	mW
Output	Collector power dissipation No derating needed	$P_C$	150	mW
	Collector-Emitter voltage	$V_{CEO}$	80	V
	Collector-Base voltage	$V_{CBO}$	80	V
	Emitter-Collector voltage	$V_{ECO}$	7	V
	Collector Current	$I_C$	50	mA
	Total Power Dissipation	$P_{TOT}$	250	mW
	Isolation Voltage*1	$V_{ISO}$	3750	V rms
	Operating Temperature	$T_{OPR}$	-55 to 110	°C
	Storage Temperature	$T_{STG}$	-55 to 125	°C
	Soldering Temperature*2	$T_{SOL}$	260	°C

Notes:

\*1 AC for 1 minute, R.H.= 40 ~ 60% R.H. In this test, pins 1, 2, 3 & 4 are shorted together, and pins 5, 6, 7 & 8 are shorted together.

\*2 For 10 seconds

**Electro-Optical Characteristics (Ta=25°C unless specified otherwise)**

**Input**

Parameter	Symbol	Min.	Typ.	Max.	Unit	Condition
Forward voltage	$V_F$	-	1.2	1.5	V	$I_F = 10\text{mA}$
Reverse current	$I_R$	-	0.1	100	$\mu\text{A}$	$V_R = 6\text{V}$
Input capacitance	$C_{in}$	-	25	-	pF	$V = 0, f = 1\text{MHz}$

**Output**

Parameter	Symbol	Min	Typ.	Max.	Unit	Condition
Collector-Emitter dark current	$I_{CEO}$	-	5.0	50	nA	$V_{CE} = 10\text{V}, I_F = 0\text{mA}$
Collector-Emitter breakdown voltage	$BV_{CEO}$	80	-	-	V	$I_C = 0.1\text{mA}$
Emitter-Collector breakdown voltage	$BV_{ECO}$	7	-	-	V	$I_E = 0.1\text{mA}$
Collector-Emitter capacitance	$C_{CE}$	-	10	-	pF	$V_{CE} = 0\text{V}, f = 1\text{MHz}$

**Transfer Characteristics**

Parameter	Symbol	Min	Typ.	Max.	Unit	Condition
Current Transfer Ratio	ELD205	40	-	80	%	$I_F = 10\text{mA}, V_{CE} = 5\text{V}$
	ELD206	63	-	125		
	ELD207	100	-	200		
	ELD211	20	-	-		
	ELD213	100	-	-		
Current Transfer Ratio	ELD205	13	30	-	%	$I_F = 1\text{mA}, V_{CE} = 5\text{V}$
	ELD206	22	45	-		
	ELD207	34	70	-		
	ELD217	100	120	-		

\* Typical values at  $T_a = 25^\circ\text{C}$

**Transfer Characteristics**

Parameter	Symbol	Min	Typ.	Max.	Unit	Condition
Collector-emitter saturation voltage	$V_{CE(sat)}$	-	-	0.4	V	$I_F = 10mA, I_C = 2.5mA$
Isolation resistance	$R_{IO}$	-	$10^{11}$	-	$\Omega$	$V_{IO} = 500Vdc$
Input-output capacitance	$C_{IO}$	-	0.5	-	pF	$V_{IO} = 0, f = 1MHz$
Turn-on time	$T_{on}$	-	5.0	-	$\mu s$	$V_{CC} = 10V,$ $I_C = 2mA, R_L = 100\Omega$
Turn-off time	$T_{off}$	-	4.0	-		
Rise time	$T_r$	-	1.6	-		
Fall time	$T_f$	-	2.2	-		

\* Typical values at  $T_a = 25^\circ C$

EVERLIGHT

Typical Electro-Optical Characteristics Curves

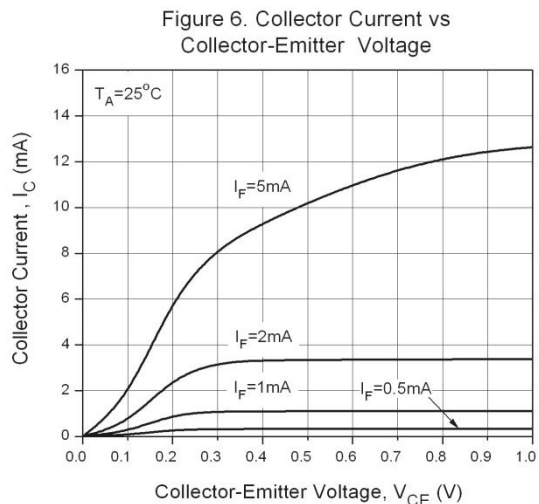
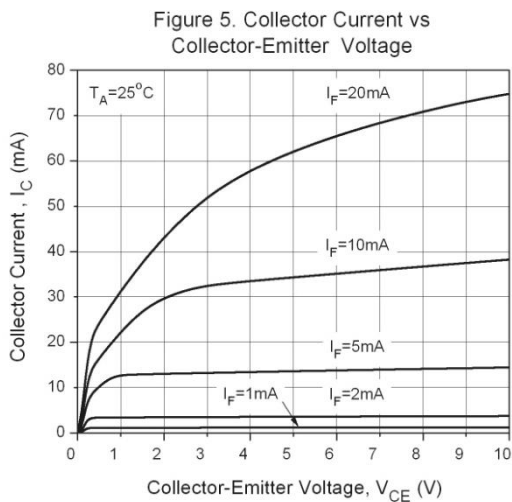
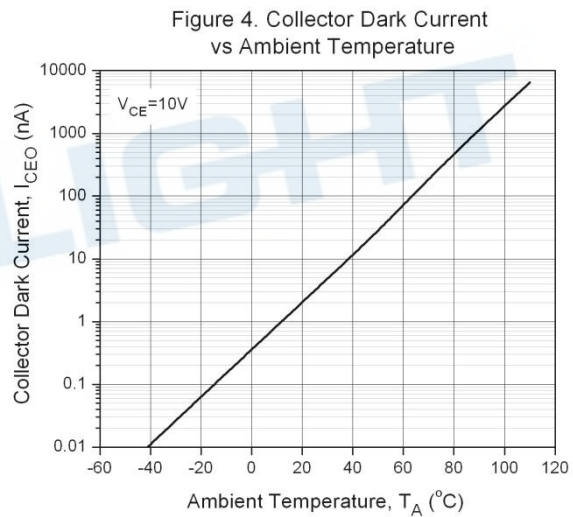
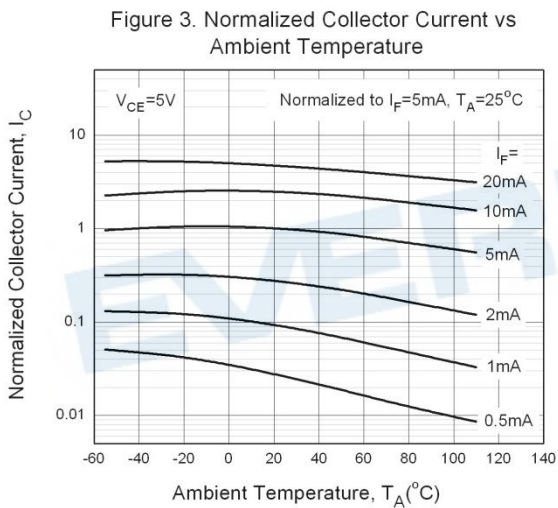
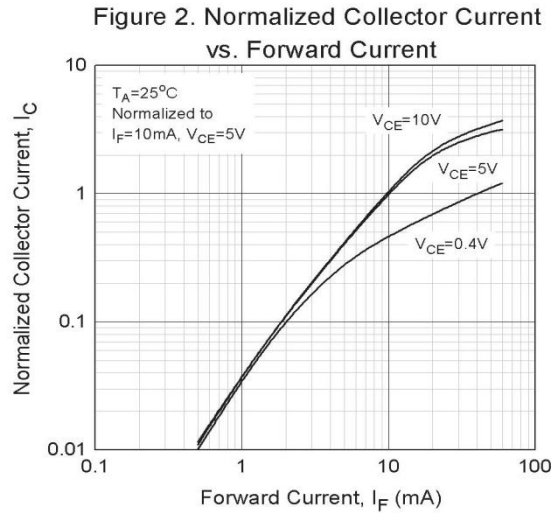
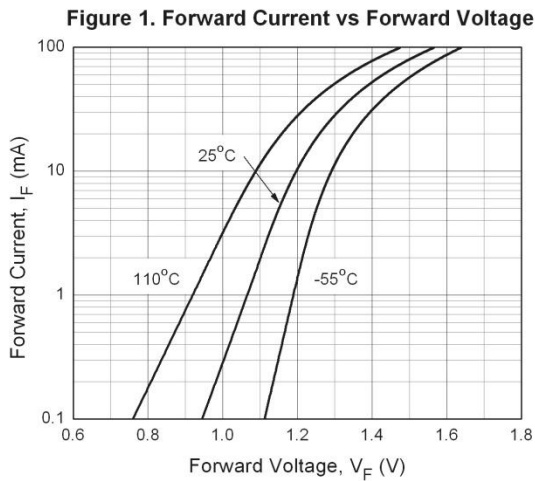

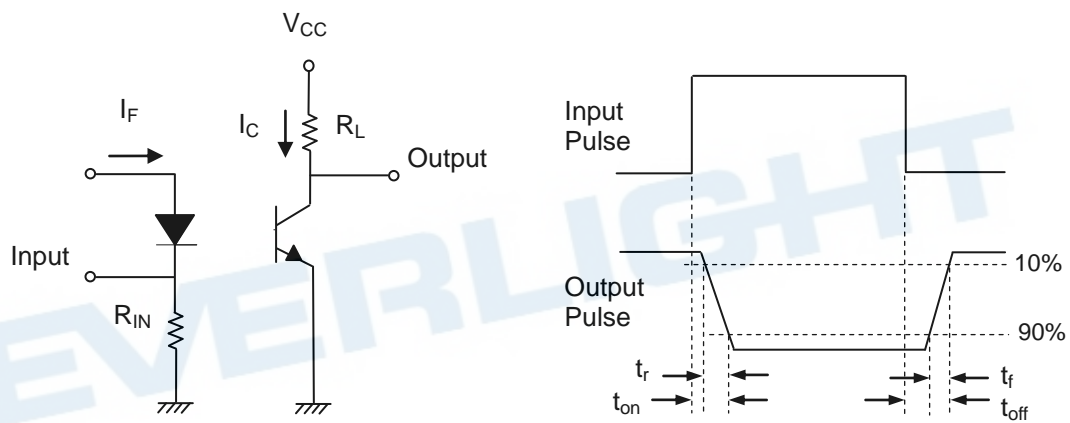
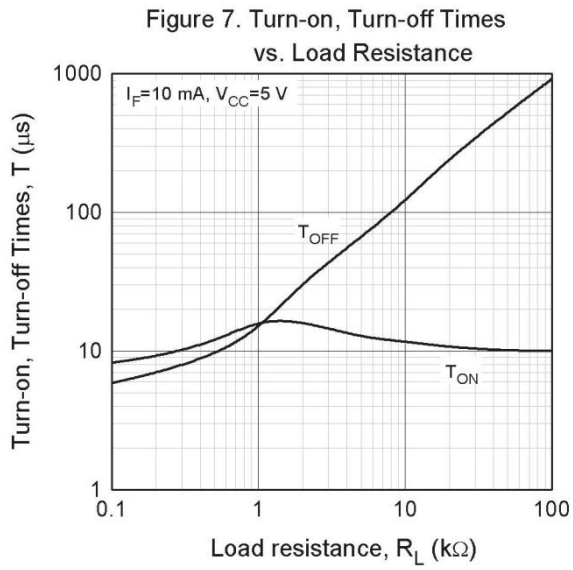

Figure 8. Switching Time Test Circuit & Waveforms

## Order Information

### Part Number

**ELD2XX(Y)-V**

### Note

- XX = Part no. (05, 06, 07, 11, 13, or 17)
- Y = Tape and reel option (TA, TB or none).
- V = VDE safety (Optional)

Option	Description	Packing quantity
None	Standard	100 units per tube
-V	Standard + VDE	100 units per tube
(TA)	TA tape & reel option	2000 units per reel
(TB)	TB tape & reel option	2000 units per reel
(TA)-V	TA tape & reel option + VDE	2000 units per reel
(TB)-V	TB tape & reel option + VDE	2000 units per reel

Package Dimension (Dimensions in mm)

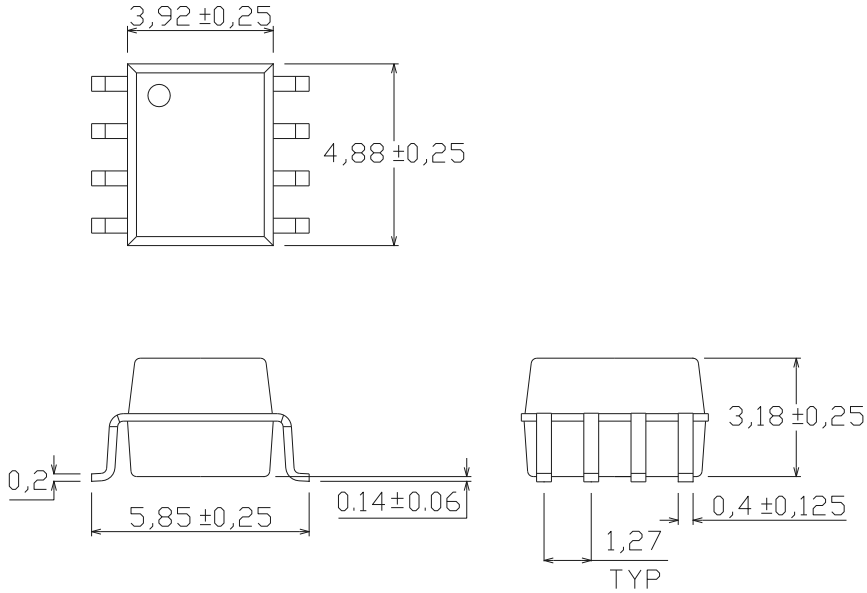

Recommended pad layout for surface mount leadform

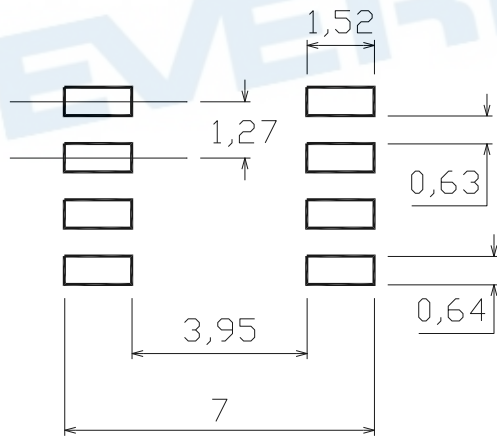



### Device Marking

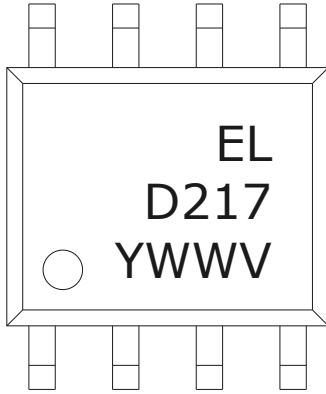

### Notes

EL	denotes Everlight
D217	denotes Part Number
Y	denotes 1 digit Year code
WW	denotes 2 digit Week code

EVERLIGHT

**Tape & Reel Packing Specifications**

**Option TA**

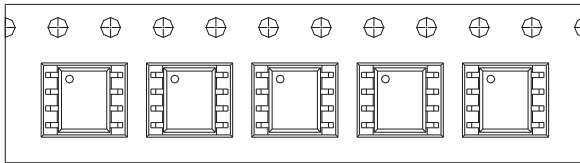

**Option TB**

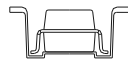
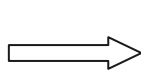
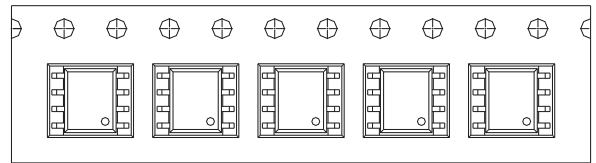

Direction of feed from reel

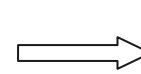

Direction of feed from reel

**Tape dimensions**

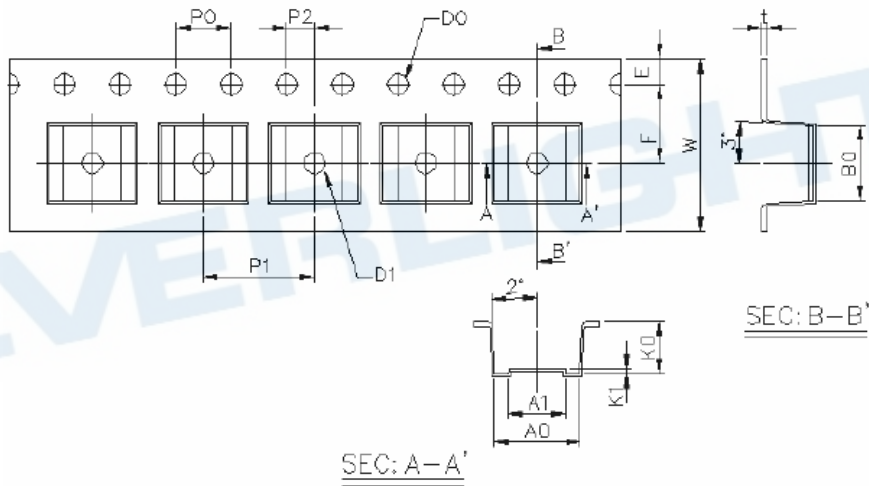

Dimension No.	<b>A0</b>	<b>A1</b>	<b>B0</b>	<b>D0</b>	<b>D1</b>	<b>E</b>	<b>F</b>
Dimension (mm)	6.2±0.1	4.1±0.1	5.28±0.1	1.5±0.1	1.5±0.3	1.75±0.1	5.5±0.1
Dimension No.	<b>Po</b>	<b>P1</b>	<b>P2</b>	<b>t</b>	<b>W</b>	<b>K0</b>	<b>K1</b>
Dimension (mm)	4.0±0.1	8.0±0.1	2.0±0.1	0.4±0.1	12.0+0.3/ -0.1	3.7±0.1	0.3±0.1

## Precautions for Use

### 1. Soldering Condition

#### 1.1 (A) Maximum Body Case Temperature Profile for evaluation of Reflow Profile

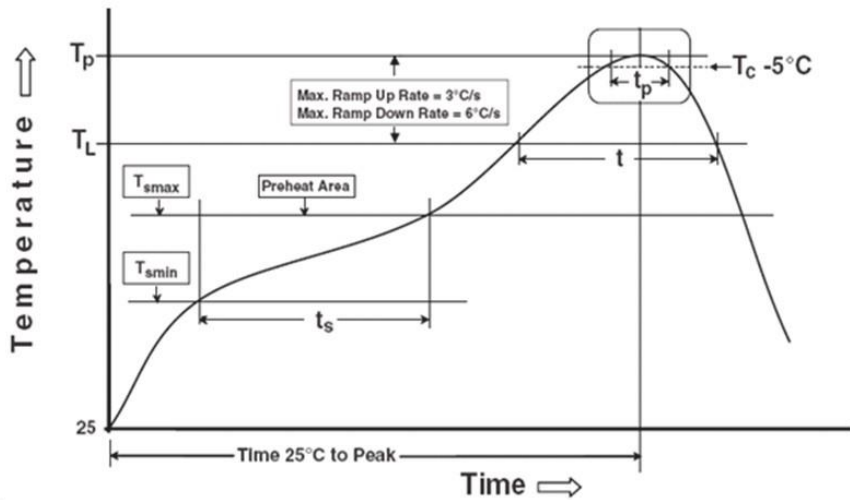

Note:

Reference: IPC/JEDEC J-STD-020D

#### Preheat

Temperature min ( $T_{smin}$ )	150 °C
Temperature max ( $T_{smax}$ )	200°C
Time ( $T_{smin}$ to $T_{smax}$ ) ( $t_s$ )	60-120 seconds
Average ramp-up rate ( $T_{smax}$ to $T_p$ )	3 °C/second max

#### Other

Liquidus Temperature ( $T_L$ )	217 °C
Time above Liquidus Temperature ( $t_L$ )	60-100 sec
Peak Temperature ( $T_p$ )	260°C
Time within 5 °C of Actual Peak Temperature: $T_p - 5^\circ\text{C}$	30 s
Ramp- Down Rate from Peak Temperature	6°C /second max.
Time 25°C to peak temperature	8 minutes max.
Reflow times	3 times

## DISCLAIMER

1. Above specification may be changed without notice. EVERLIGHT will reserve authority on material change for above specification.
2. When using this product, please observe the absolute maximum ratings and the instructions for using outlined in these specification sheets. EVERLIGHT assumes no responsibility for any damage resulting from use of the product which does not comply with the absolute maximum ratings and the instructions included in these specification sheets.
3. These specification sheets include materials protected under copyright of EVERLIGHT corporation. Please don't reproduce or cause anyone to reproduce them without EVERLIGHT's consent.

EVERLIGHT

# Mouser Electronics

Authorized Distributor

Click to View Pricing, Inventory, Delivery & Lifecycle Information:

## Everlight:

[ELD205](#) [ELD205\(TA\)](#) [ELD205\(TA\)-V](#) [ELD205\(TB\)](#) [ELD205\(TB\)-V](#) [ELD205-V](#) [ELD206](#) [ELD206\(TA\)](#) [ELD206\(TA\)-V](#) [ELD206\(TB\)](#) [ELD206\(TB\)-V](#) [ELD206-V](#) [ELD207](#) [ELD207\(TA\)](#) [ELD207\(TA\)-V](#) [ELD207\(TB\)](#) [ELD207\(TB\)-V](#) [ELD207-V](#) [ELD211](#) [ELD211\(TA\)](#) [ELD211\(TA\)-V](#) [ELD211\(TB\)](#) [ELD211\(TB\)-V](#) [ELD211-V](#) [ELD213](#) [ELD213\(TA\)](#) [ELD213\(TA\)-V](#) [ELD213\(TB\)](#) [ELD213\(TB\)-V](#) [ELD213-V](#) [ELD217\(TA\)](#) [ELD217\(TA\)-V](#) [ELD217\(TB\)](#) [ELD217\(TB\)-V](#) [ELD217-V](#)